



LED Tube Light LED Cabinet Light

60%
energy saving

50,000
hours life

5 years
warranty

T8 LED Tube

General :95-105LM/W Premium :120-130LM/W Deluxe:140-150LM/W



VDE

5 YR

Features

- > VDE/TUV/CE/ROHS approval
- > Rotatable end cap
- > Up to 60% energy savings
- > 50,000 hours life span
- > 5 years warranty

Applications

- > Industrial Lighting: Factory, Warehouse
- > Commercial Lighting: Office, Super-market
Hotel, Exhibition hall
- > Public Lighting: Residence, Library, Hospital
School, MTR station, Bus station
Train station, Airport

Options

- > Lumen efficacy :
General : 95-105LM/W
Premium : 120-130LM/W
Deluxe : 140-150LM/W
- > Cap Ring Color : Various color
- > PC cover: Clear or Frosted
- > Pink color for meat

Photometry Curve

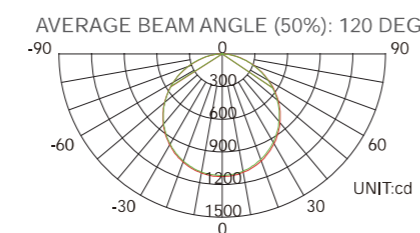

Data Sheet

General Version : 95-105LM/W

Order Code	Product Name	Rated Power	Lumen Output	Lumen Efficacy	Color Index	AC Input	Power Factor	Match
T802-10GN1-DMN6B-001	60CM-10W General T8 Tube	10W	1000LM	100LM/W	Ra>80	AC100-277V	PF>0.95	Inductive ballast
T804-18GN1-DMN6B-001	120CM-18W General T8 Tube	18W	1800LM	100LM/W	Ra>80	AC100-277V	PF>0.95	Inductive ballast
T804-20GN1-DMN6B-001	120CM-20W General T8 Tube	20W	2000LM	100LM/W	Ra>80	AC100-277V	PF>0.95	Inductive ballast
T805-22GN1-DMN6B-001	150CM-22W General T8 Tube	22W	2200LM	100LM/W	Ra>80	AC100-277V	PF>0.95	Inductive ballast
T805-25GN1-DMN6B-001	150CM-25W General T8 Tube	25W	2500LM	100LM/W	Ra>80	AC100-277V	PF>0.95	Inductive ballast
T805-30GN1-DMN6B-001	150CM-30W General T8 Tube	30W	3000LM	100LM/W	Ra>80	AC100-277V	PF>0.95	Inductive ballast

Premium Version : 120-130LM/W

Order Code	Product Name	Rated Power	Lumen Output	Lumen Efficacy	Color Index	AC Input	Power Factor	Match
T802-10PN1-DMN6B-001	60CM-10W Premium T8 Tube	10W	1200LM	120LM/W	Ra>80	AC100-277V	PF>0.95	Inductive ballast
T804-18PN1-DMN6B-001	120CM-18W Premium T8 Tube	18W	2150LM	120LM/W	Ra>80	AC100-277V	PF>0.95	Inductive ballast
T804-20PN1-DMN6B-001	120CM-20W Premium T8 Tube	20W	2400LM	120LM/W	Ra>80	AC100-277V	PF>0.95	Inductive ballast
T805-22PN1-DMN6B-001	150CM-22W Premium T8 Tube	22W	2650LM	120LM/W	Ra>80	AC100-277V	PF>0.95	Inductive ballast
T805-25PN1-DMN6B-001	150CM-25W Premium T8 Tube	25W	3000LM	120LM/W	Ra>80	AC100-277V	PF>0.95	Inductive ballast
T805-30PN1-DMN6B-001	150CM-30W Premium T8 Tube	30W	3600LM	120LM/W	Ra>80	AC100-277V	PF>0.95	Inductive ballast

Deluxe Version : 120-130LM/W

Order Code	Product Name	Rated Power	Lumen Output	Lumen Efficacy	Color Index	AC Input	Power Factor	Match
T802-10DN1-DMN6B-001	60CM-10W Deluxe T8 Tube	10W	1400LM	140LM/W	Ra>80	AC100-277V	PF>0.95	Inductive ballast
T804-18DN1-DMN6B-001	120CM-18W Deluxe T8 Tube	18W	2500LM	140LM/W	Ra>80	AC100-277V	PF>0.95	Inductive ballast
T804-20DN1-DMN6B-001	120CM-20W Deluxe T8 Tube	20W	2800LM	140LM/W	Ra>80	AC100-277V	PF>0.95	Inductive ballast
T805-22DN1-DMN6B-001	150CM-22W Deluxe T8 Tube	22W	3080LM	140LM/W	Ra>80	AC100-277V	PF>0.95	Inductive ballast
T805-25DN1-DMN6B-001	150CM-25W Deluxe T8 Tube	25W	3500LM	140LM/W	Ra>80	AC100-277V	PF>0.95	Inductive ballast
T805-30DN1-DMN6B-001	150CM-30W Deluxe T8 Tube	30W	4200LM	140LM/W	Ra>80	AC100-277V	PF>0.95	Inductive ballast



Dimensions

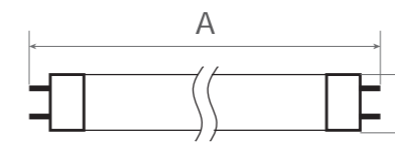

Product Name	A	B
60cm/2ft	603±1	26
120cm/4ft	1212±1	26
150cm/5ft	1513±1	26

Unit: mm

T6 LED Tube

General :95-105LM/W Premium :120-130LM/W



Data Sheet



General Version : 95-105LM/W

Order Code	Product Name	Rated Power	Lumen Output	Lumen Efficacy	Color Index	AC Input	Power Factor	Match
T602-10GN1-DMN6B-001	60CM-10W General T6 Tube	10W	1000LM	100LM/W	Ra>80	AC100-277V	PF>0.95	T5 fluorescent
T604-18GN1-DMN6B-001	120CM-18W General T6 Tube	18W	1800LM	100LM/W	Ra>80	AC100-277V	PF>0.95	T5 fluorescent
T605-22GN1-DMN6B-001	150CM-22W General T6 Tube	22W	2200LM	100LM/W	Ra>80	AC100-277V	PF>0.95	T5 fluorescent
T605-25GN1-DMN6B-001	150CM-25W General T6 Tube	25W	2500LM	100LM/W	Ra>80	AC100-277V	PF>0.95	T5 fluorescent
T605-30GN1-DMN6B-001	150CM-30W General T6 Tube	30W	3000LM	100LM/W	Ra>80	AC100-277V	PF>0.95	T5 fluorescent

Premium Version : 120-130LM/W

Order Code	Product Name	Rated Power	Lumen Output	Lumen Efficacy	Color Index	AC Input	Power Factor	Match
T602-10PN1-DMN6B-001	60CM-10W Premium T6 Tube	10W	1200LM	120LM/W	Ra>80	AC100-277V	PF>0.95	T5 fluorescent
T604-18PN1-DMN6B-001	120CM-18W Premium T6 Tube	18W	2150LM	120LM/W	Ra>80	AC100-277V	PF>0.95	T5 fluorescent
T605-22PN1-DMN6B-001	150CM-22W Premium T6 Tube	22W	2650LM	120LM/W	Ra>80	AC100-277V	PF>0.95	T5 fluorescent
T605-25PN1-DMN6B-001	150CM-25W Premium T6 Tube	25W	3000LM	120LM/W	Ra>80	AC100-277V	PF>0.95	T5 fluorescent
T605-30PN1-DMN6B-001	150CM-30W Premium T6 Tube	30W	3600LM	120LM/W	Ra>80	AC100-277V	PF>0.95	T5 fluorescent



5 YR

Features

- > Special Design for G5 cap
- > Up to 60% energy savings
- > 50,000 hours life span
- > 5 years warranty

Options

- > Lumen efficacy :
General : 95-105 LM/W
Premium : 120-130LM/W
- > Cap Ring Color : Various color
- > PC cover: Clear or Frosted
- > Pink color for meat

Applications

- > Industrial Lighting: Factory, Warehouse
- > Commercial Lighting: Office, Super-market
Hotel, Exhibition hall
- > Public Lighting: Residence, Library, Hospital
School, MTR station, Bus station
Train station, Airport

Photometry Curve

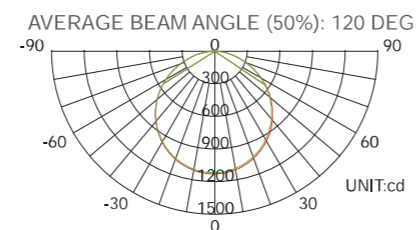

Dimensions

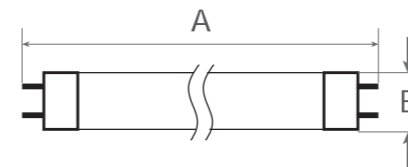

Product Name	A	B
30cm/1ft	288±1	22
60cm/2ft	549±1	22
120cm/4ft	1148±1	22
150cm/5ft	1449±1	22

Unit: mm

Photometry Curve

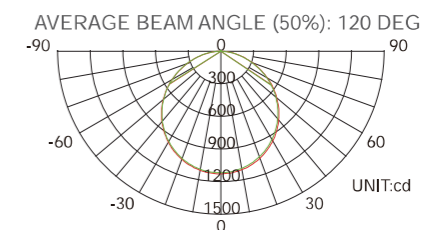

Nano LED Tube

Standard : 95-105LM/W Advance:120-130LM/W Ritzy :140-150LM/W



Features

- > Various LM/W output version
- > Housing material : Nano case
- > New LED Technology SMD2835 as the light source
- > AC200-240V Input Voltage
- > 3 years warranty

Applications

- > Industrial Lighting: Factory, Warehouse
- > Commercial Lighting: Office, Super-market
Hotel, Exhibition hall
- > Public Lighting: Residence, Library, Hospital
School, MTR station, Bus station
Train station, Airport

Options

- > Lumen efficacy:
Standard :100-110LM/W,
Advance:130-140LM/W,
Ritzy:150-160LM/W

Photometry Curve

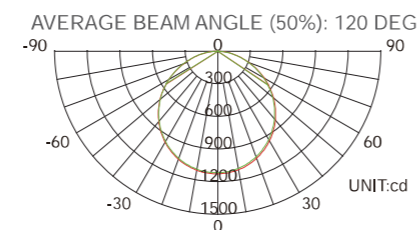

Data Sheet

Standard Version : 95-105LM/W

Order Code	Product Name	Rated Power	Lumen Output	Lumen Efficacy	Color Index	AC Input	Flicker Free	Match
T802-10GN1-NMN2H-001	60CM-10W standard nano tube	10W	1000LM	100LM/W	Ra>80	AC200-240V	Y	Inductive ballast
T804-18GN1-NMN2H-001	120CM-18W standard nano tube	18W	1800LM	100LM/W	Ra>80	AC200-240V	Y	Inductive ballast
T805-24GN1-NMN2H-001	150CM-24W standard nano tube	24W	2400LM	100LM/W	Ra>80	AC200-240V	Y	Inductive ballast
T806-30GN1-NMN2H-001	180CM-30W standard nano tube	30W	3000LM	100LM/W	Ra>80	AC200-240V	Y	Inductive ballast

Advance Version : 130-140LM/W

Order Code	Product Name	Rated Power	Lumen Output	Lumen Efficacy	Color Index	AC Input	Flicker Free	Match
T802-10AN1-NMN2H-001	60CM-10W advance nano tube	10W	1300LM	130LM/W	Ra>80	AC200-240V	Y	Inductive ballast
T804-18AN1-NMN2H-001	120CM-18W advance nano tube	18W	2350LM	130LM/W	Ra>80	AC200-240V	Y	Inductive ballast
T805-24AN1-NMN2H-001	150CM-24W advance nano tube	24W	3100LM	130LM/W	Ra>80	AC200-240V	Y	Inductive ballast
T806-30AN1-NMN2H-001	180CM-30W advance nano tube	30W	3900LM	130LM/W	Ra>80	AC200-240V	Y	Inductive ballast

Ritzy Version : 150-160LM/W

Order Code	Product Name	Rated Power	Lumen Output	Lumen Efficacy	Color Index	AC Input	Flicker Free	Match
T802-10RN1-NMN2H-001	60CM-10W ritzy nano tube	10W	1500LM	150LM/W	Ra>80	AC200-240V	Y	Inductive ballast
T804-18RN1-NMN2H-001	120CM-18W ritzy nano tube	18W	2700LM	150LM/W	Ra>80	AC200-240V	Y	Inductive ballast
T805-24RN1-NMN2H-001	150CM-24W ritzy nano tube	24W	3600LM	150LM/W	Ra>80	AC200-240V	Y	Inductive ballast
T806-30RN1-NMN2H-001	180CM-30W ritzy nano tube	30W	4500LM	150LM/W	Ra>80	AC200-240V	Y	Inductive ballast



Dimensions

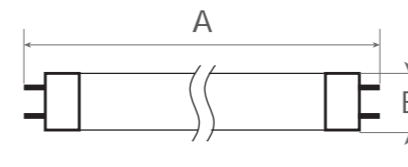

Product Name	A	B
60cm/2ft	603±1	26
120cm/4ft	1212±1	26
150cm/5ft	1513±1	26
180cm/6ft	1777±1	26

Unit: mm

LED Cabinet Light

Multiple Link with Wireless or Wire Connector



Data Sheet

Order Code	Product Name	Rated Power	Lumen Output	Lumen Efficacy	Color Index	AC Input	Flicker free	LED Qty
CB02-03GN1-AFN2H-001	20CM-03W cabinet light	3W	300LM	100LM/W	Ra>80	AC200-240V	Y	20 SMD2835
CB03-05GN1-AFN2H-001	30CM-05W cabinet light	5W	500LM	100LM/W	Ra>80	AC200-240V	Y	30 SMD2835
CB05-08GN1-AFN2H-001	50CM-08W cabinet light	9W	900LM	100LM/W	Ra>80	AC200-240V	Y	48 SMD2835
CB09-14GN1-AFN2H-001	90CM-14W cabinet light	14W	1400LM	100LM/W	Ra>80	AC200-240V	Y	84 SMD2835
CB12-16GN1-AFN2H-001	120CM-16W cabinet light	16W	1600LM	100LM/W	Ra>80	AC200-240V	Y	96 SMD2835



Accessories



Dimensions

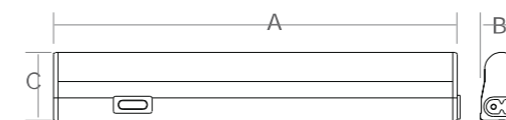

Product Name	A	B	C
20cm	222	23	37
30cm	295	23	37
50cm	525	23	37
80cm	857	23	37
120cm	1157	23	37

Unit: mm

Switch ON/OFF
Flicker Free
3 YR

Features

- > Ideal for retro-fit of existing T4 and T5 fixtures
- > Available in 5 different lengths
- > Full set of connectors and accessories supplied
- > Slimline profile for discreet installation
- > Extruded plastic body
- > 3 years warranty

Applications

- > Cupboard, Showcase, Shopping mall

Options

- > Multiple link :
Wireless or wire connector (see accessories)
- > Emitting color
WW - Warm white (3000K)
NW - Neutral white (4000K)
PW - Daylight white (5000K)

Photometry Curve

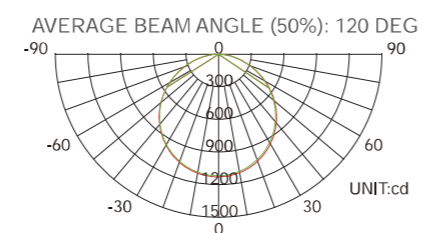

PRODUCTS

LED SHELF LIGHT SYSTEM

PRODUCT CUSTOMIZATION

All of our products comply with international quality standards and are greatly appreciated in a variety of different markets throughout the world.

[VIEW MORE+](#)



PRODUCTS

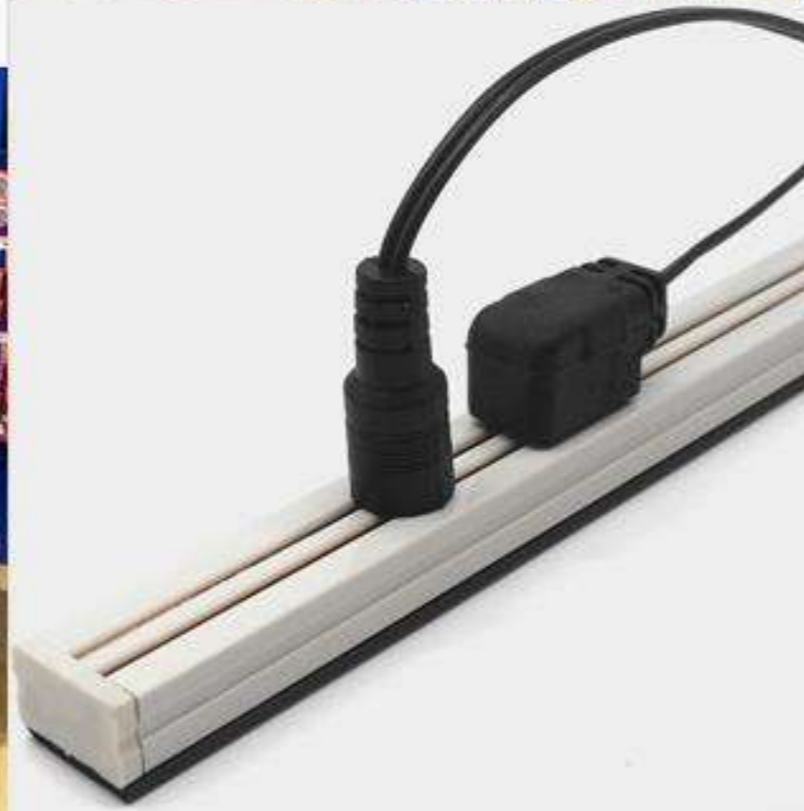
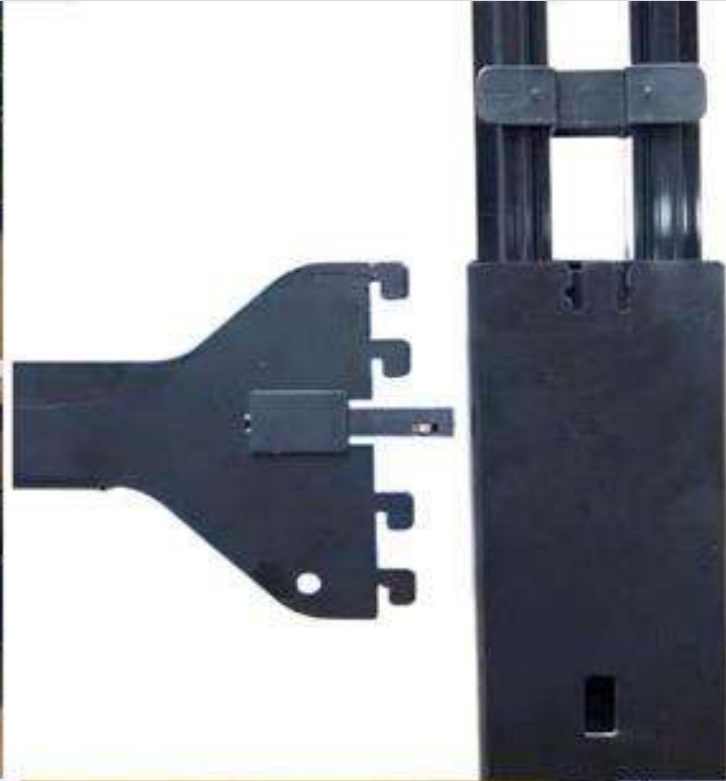
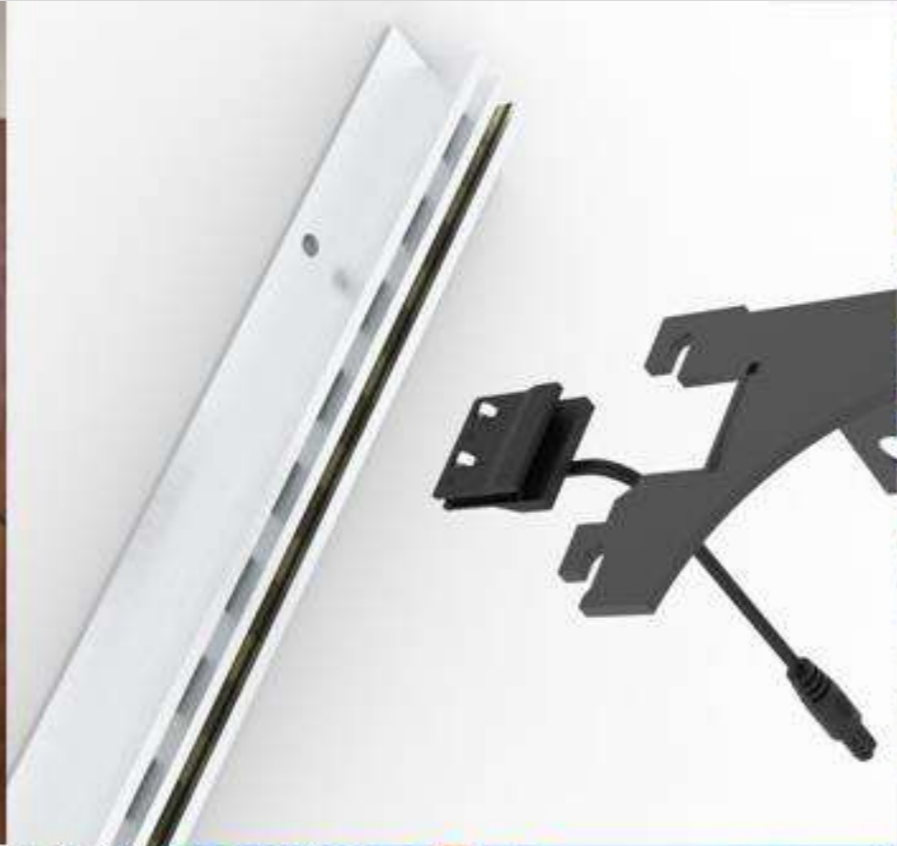

PRODUCTS

**LED GLASS
SHELF LIGHT**

6-12mm thickness glass

[View More](#)



PRODUCTS

LED Cabinet Light



Wine Cabinet



Wardrobe



Cupboard

PRODUCTS

FREEZER LIGHT

- | IP65 waterproof |
- | Strong heat dissipation capacity |
- | Energy conservation |
- | Good light effect |

[View More >](#)



PROJECT CASES

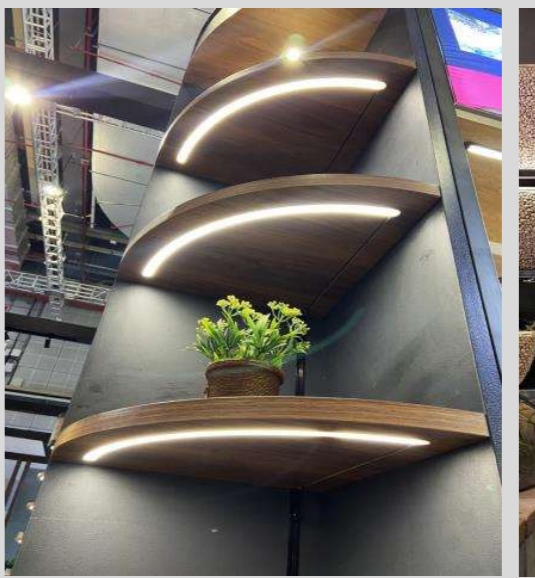

PRODUCTS

Led Shelf Light



Power Track System



Under Cabinet Light



LED Freezer Light



LED Display Light



T5 Tube Light



T8 Tube Light



LED Linear light



LED Strip Light



RGB Neon Strip

LED High Bay Light
14-18



Trunk Linear System
22-26

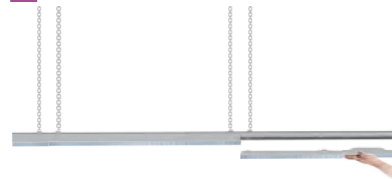

LED Track Panel
30



LED Bulkheads
98-102



LED Wall Pack
104



LED Ceiling Light
108-110



LED Linear Light
LED Batten Light
34-60



LED Tri-proof Light
64-72



LED Tubar Light
76



LED Down Light
114



LED Slim Down Light
116



LED Tube Light
120-124



LED Panel Light
80-92



LED Troffer Light
94



LED Cabinet Light
126



LED High Bay Light

60%
energy saving

50,000
hours life

5 years
warranty

LED Fins High Bay

Patent designed heatsink with Rotatable module



UGR <19

8 YR

Features

- > Rotatable LED module
- > Patent designed fins fixture as heat sink
- > 30/60/90 viewing angle
- > 3H EM @20W
- > PIR sensor function
- > Micro-wave sensor function

Options

- > Micro-wave sensor :
Off : 0%, ON :100%
Standby : 15% , ON:100%
- > Viewing Angle : 30/60/90
- > AC Input :
AC100-277V, AC100-384V
AC384V single, AC100-240V
- > Dimming : 1-10V / DALI / PIR / MS
- > Installation : Chain /Cable Mount ,Rod Mount

Applications

- > Traditional lamp replacement
- > Factories / Warehouses /Car parks
- > Supermarkets / Gas Stations

Data sheet



Standard : ON-Off

Order Code	Product Name	Rated Power	Lumen Output	Lumen Efficacy	Color Index	Beam Angle	AC Input	Power Factor	Flicker Free
HB55-1ADN1-FLN1M-001	100W STD Fins High Bay	100W	14000LM	140LM/W	Ra>80	30/60/90	AC100-277V	PF>0.95	Y
HB55-1BDN1-FLN1M-001	150W STD Fins High Bay	150W	21000LM	140LM/W	Ra>80	30/60/90	AC100-277V	PF>0.95	Y
HB55-2ADN1-FLN1M-001	200W STD Fins High Bay	200W	28000LM	140LM/W	Ra>80	30/60/90	AC100-277V	PF>0.95	Y

1-10V dimming

Order Code	Product Name	Rated Power	Lumen Output	Lumen Efficacy	Color Index	Beam Angle	AC Input	Power Factor	Flicker Free
HB55-1ADN1-FLV1M-001	100W 1-10V Fins High Bay	100W	14000LM	140LM/W	Ra>80	30/60/90	AC100-277V	PF>0.95	Y
HB55-1BDN1-FLV1M-001	150W 1-10V Fins High Bay	150W	21000LM	140LM/W	Ra>80	30/60/90	AC100-277V	PF>0.95	Y
HB55-2ADN1-FLV1M-001	200W 1-10V Fins High Bay	200W	28000LM	140LM/W	Ra>80	30/60/90	AC100-277V	PF>0.95	Y

Micro-wave sensor Function A : OFF /0% ON /100% Function B: Standby /15% , ON /100%

Order Code	Product Name	Rated Power	Lumen Output	Lumen Efficacy	Color Index	Beam Angle	AC Input	Power Factor	Flicker Free
HB55-1ADN1-FLM1M-001	100W 1-10V Fins High Bay	100W	14000LM	140LM/W	Ra>80	30/60/90	AC100-277V	PF>0.95	Y
HB55-1BDN1-FLM1M-001	150W 1-10V Fins High Bay	150W	21000LM	140LM/W	Ra>80	30/60/90	AC100-277V	PF>0.95	Y
HB55-2ADN1-FLM1M-001	200W 1-10V Fins High Bay	200W	28000LM	140LM/W	Ra>80	30/60/90	AC100-277V	PF>0.95	Y

PIR sensor

Order Code	Product Name	Rated Power	Lumen Output	Lumen Efficacy	Color Index	Beam Angle	AC Input	Power Factor	Flicker Free
HB55-1ADN1-FLP1M-001	100W 1-10V Fins High Bay	100W	14000LM	140LM/W	Ra>80	30/60/90	AC100-277V	PF>0.95	Y
HB55-1BDN1-FLP1M-001	150W 1-10V Fins High Bay	150W	21000LM	140LM/W	Ra>80	30/60/90	AC100-277V	PF>0.95	Y
HB55-2ADN1-FLP1M-001	200W 1-10V Fins High Bay	200W	28000LM	140LM/W	Ra>80	30/60/90	AC100-277V	PF>0.95	Y

Emergency : 3H @20W

Order Code	Product Name	Rated Power	Lumen Output	Lumen Efficacy	Color Index	Beam Angle	AC Input	Power Factor	Flicker Free
HB55-1ADN1-FLE1M-001	100W 1-10V Fins High Bay	100W	14000LM	140LM/W	Ra>80	30/60/90	AC100-277V	PF>0.95	Y
HB55-1BDN1-FLE1M-001	150W 1-10V Fins High Bay	150W	21000LM	140LM/W	Ra>80	30/60/90	AC100-277V	PF>0.95	Y
HB55-2ADN1-FLE1M-001	200W 1-10V Fins High Bay	200W	28000LM	140LM/W	Ra>80	30/60/90	AC100-277V	PF>0.95	Y



Dimensions

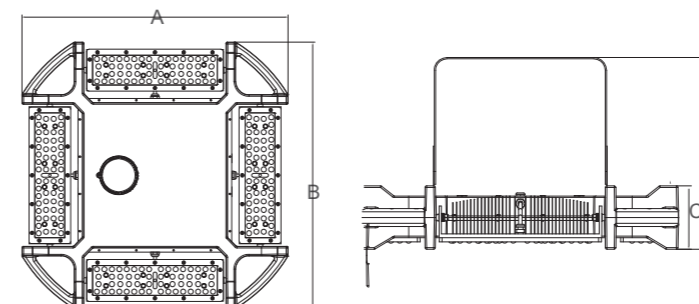

Product Name	A	B	C	D
Fins high bay	500	500	100	303

Unit:mm

LED Gentle Linear High Bay

Gentle Version / 130LM/W with PC cover



1~10V dimming

5 YR

Features

- > Rated power : 80-300W
- > 130Lm/W and 50,000h life span
- > Steel case as heat sink
- > Custom-made dimension

Applications

- > Traditional lamp replacement
- > Factories / Warehouses
- > Supermarkets / schools
- > Car Parks / Gas stations

Options

- > Dimming: On-off or 1-10V
- > CCT: WW:3000K, NW:4000K, PW:5000K, CW:6000K
- > AC Input :
 - AC100-277V, AC100-384V
 - AC384V single, AC100-240V
- > Installation : Chain /Cable Mount , Rod Mount

Dimensions

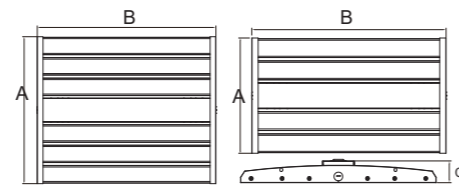

Product Name	A	B	C
1x2ft	338	625	56.2
2x2ft	458	625	56.2
1x4ft	338	1225	56.2
2x4ft	458	1225	56.2

Unit:mm

EU Style



• Data Sheet

Order Code	Product Name	Rated Power	Lumen Output	Lumen Efficacy	Color Index	Beam Agree	AC Input	Power Factor	Flicker Free
HB12-80AN1- GMN1S-001	1x2ft 80W Gentle GS linear high bay	80W	10400LM	130LM/W	Ra>80	120	AC200-240V	PF>0.95	Y
HB12-1AAN1- GMN1S-001	1x2ft 100W Gentle GS linear high bay	100W	13000LM	130LM/W	Ra>80	120	AC200-240V	PF>0.95	Y
HB22-1BAN1- GMN1S-001	2x2ft 150W Gentle GS linear high bay	150W	19500LM	130LM/W	Ra>80	120	AC200-240V	PF>0.95	Y
HB22-2AAN1- GMN1S-001	2x2ft 200W Gentle GS linear high bay	200W	26000LM	130LM/W	Ra>80	120	AC200-240V	PF>0.95	Y
HB14-1BAN1- GMN1S-001	1x4ft 150W Gentle GS linear high bay	150W	19500LM	130LM/W	Ra>80	120	AC200-240V	PF>0.95	Y
HB14-2AAN1- GMN1S-001	1x4ft 200W Gentle GS linear high bay	200W	26000LM	130LM/W	Ra>80	120	AC200-240V	PF>0.95	Y
HB24-3AAN1- GMN1S-001	2x4ft 300W Gentle GS linear high bay	300W	39000LM	130LM/W	Ra>80	120	AC200-240V	PF>0.95	Y

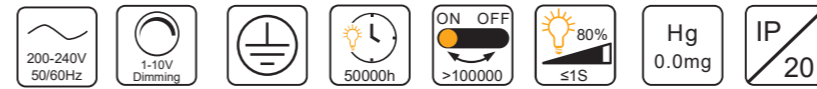

North American Style



• Data Sheet

Order Code	Product Name	Rated Power	Lumen Output	Lumen Efficacy	Color Index	Beam Agree	AC Input	Power Factor	Flicker Free
HB12-80AN1- GMV1M-500	1x2ft 80W Gentle ETL linear high bay	80W	10400LM	130LM/W	Ra>80	120	AC100-277V	PF>0.95	Y
HB12-1AAN1- GMV1M-500	1x2ft 100W Gentle ETL linear high bay	100W	13000LM	130LM/W	Ra>80	120	AC100-277V	PF>0.95	Y
HB22-1BAN1- GMV1M-500	2x2ft 150W Gentle ETL linear high bay	150W	19500LM	130LM/W	Ra>80	120	AC100-277V	PF>0.95	Y
HB22-2AAN1- GMV1M-500	2x2ft 200W Gentle ETL linear high bay	200W	26000LM	130LM/W	Ra>80	120	AC100-277V	PF>0.95	Y
HB14-1BAN1- GMV1M-500	1x4ft 150W Gentle ETL linear high bay	150W	19500LM	130LM/W	Ra>80	120	AC100-277V	PF>0.95	Y
HB14-2AAN1- GMV1M-500	1x4ft 200W Gentle ETL linear high bay	200W	26000LM	130LM/W	Ra>80	120	AC100-277V	PF>0.95	Y
HB24-3AAN1- GMV1M-500	2x4ft 300W Gentle ETL linear high bay	300W	39000LM	130LM/W	Ra>80	120	AC100-277V	PF>0.95	Y

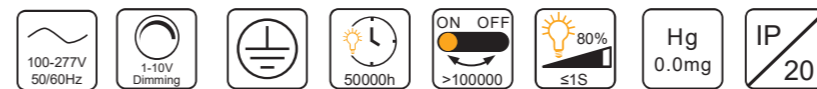

Installation

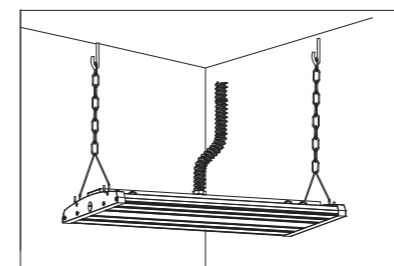

Chain / Cable suspension

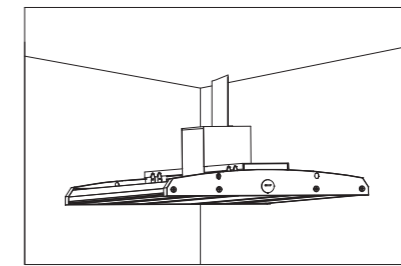

Rod mount

LED Reflective Linear High Bay

Reflective Version / 140LM/W with lens



1~10V dimming

5 YR

Features

- > Rated power : 80-300W
- > 140Lm/W and 50,000H life span
- > 30/60/90/Double25 viewing angle
- > Steel case as heat sink
- > Custom-made dimension

Applications

- > Traditional lamp replacement
- > Factories / Warehouses
- > Supermarkets / schools
- > Car Parks / Gas stations

Options

- > Dimming: On-off or 1-10V
- > CCT: WW:3000K, NW:4000K, PW:5000K, CW:6000K
- > AC Input :
 - AC100-277V, AC100-384V
 - AC384V single, AC100-240V
- > Installation : Chain /Cable Mount , Rod Mount

Dimensions

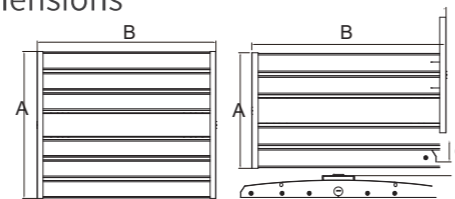

Product Name	A	B	C
1x2ft	338	625	56.2
2x2ft	458	625	56.2
1x4ft	338	1225	56.2
2x4ft	458	1225	56.2

Unit:mm

EU Style



Data Sheet

Order Code	Product Name	Rated Power	Lumen Output	Lumen Efficacy	Color Index	Beam Agree	AC Input	Power Factor	Flicker Free
HB12-80DN1-RLN1S-001	1x2ft 80W Reflective GS linear high bay	80W	11200LM	140LM/W	Ra>80	30/60/90	AC200-240V	PF>0.95	Y
HB12-1ADN1-RLN1S-001	1x2ft 100W Reflective GS linear high bay	100W	14000LM	140LM/W	Ra>80	30/60/90	AC200-240V	PF>0.95	Y
HB22-1BDN1-RLN1S-001	2x2ft 150W Reflective GS linear high bay	150W	21000LM	140LM/W	Ra>80	30/60/90	AC200-240V	PF>0.95	Y
HB22-2ADN1-RLN1S-001	2x2ft 200W Reflective GS linear high bay	200W	28000LM	140LM/W	Ra>80	30/60/90	AC200-240V	PF>0.95	Y
HB14-1BDN1-RLN1S-001	1x4ft 150W Reflective GS linear high bay	150W	21000LM	140LM/W	Ra>80	30/60/90	AC200-240V	PF>0.95	Y
HB14-2ADN1-RLN1S-001	1x4ft 200W Reflective GS linear high bay	200W	28000LM	140LM/W	Ra>80	30/60/90	AC200-240V	PF>0.95	Y
HB24-3ADN1-RLN1S-001	2x4ft 300W Reflective GS linear high bay	300W	42000LM	140LM/W	Ra>80	30/60/90	AC200-240V	PF>0.95	Y

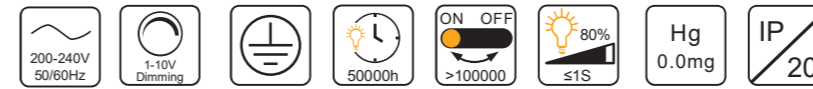

North American Style



Data Sheet

Order Code	Product Name	Rated Power	Lumen Output	Lumen Efficacy	Color Index	Beam Agree	AC Input	Power Factor	Flicker Free
HB12-80DN1-RLV1M-500	1x2ft 80W Reflective ETL linear high bay	80W	11200LM	140LM/W	Ra>80	30/60/90	AC100-277V	PF>0.95	Y
HB12-1ADN1-RLV1M-500	1x2ft 100W Reflective ETL linear high bay	100W	14000LM	140LM/W	Ra>80	30/60/90	AC100-277V	PF>0.95	Y
HB22-1BDN1-RLV1M-500	2x2ft 150W Reflective ETL linear high bay	150W	21000LM	140LM/W	Ra>80	30/60/90	AC100-277V	PF>0.95	Y
HB22-2ADN1-RLV1M-500	2x2ft 200W Reflective ETL linear high bay	200W	28000LM	140LM/W	Ra>80	30/60/90	AC100-277V	PF>0.95	Y
HB14-1BDN1-RLV1M-500	1x4ft 150W Reflective ETL linear high bay	150W	21000LM	140LM/W	Ra>80	30/60/90	AC100-277V	PF>0.95	Y
HB14-2ADN1-RLV1M-500	1x4ft 200W Reflective ETL linear high bay	200W	28000LM	140LM/W	Ra>80	30/60/90	AC100-277V	PF>0.95	Y
HB24-3ADN1-RLV1M-500	2x4ft 300W Reflective ETL linear high bay	300W	42000LM	140LM/W	Ra>80	30/60/90	AC100-277V	PF>0.95	Y



Installation

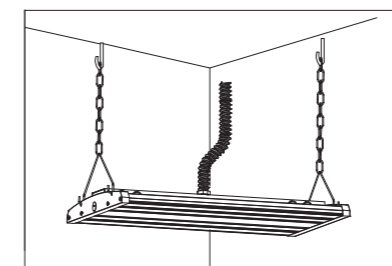

Chain / Cable suspension

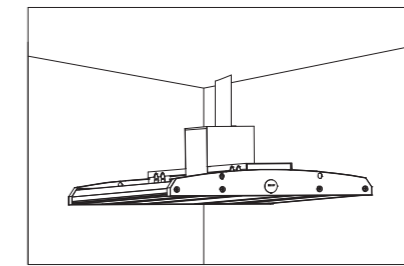

Rod mount



Trunk Linear System

60%
energy saving

50,000
hours life

5 years
warranty

Brighton Trunk Linear System

Product Design | Profile

- > BRIGHTON trunk linear system is a patent and own designed multiple link LED linear lighting system ,Which provide the optimized lighting solution for the industrial applications and commercial applications . Such as : Supermarkets , Shopping malls , Offices , Conference rooms , Factories, Warehouses, Car parks , Airports, Stations ,Etc .
- > BRIGHTON trunk linear system comprises of trunk rail ,module and accessories . The trunk rail is pre-wired which provide the AC power and control signals to modules . The trunk rail has 5/7/11 wires style which meet the different modules .The modules split into lighting module and function module, 5 different lighting modules in tri-color and 5 different function modules make the BRIGHTON trunk linear system meet the different applications.
- > BRIGHTON trunk linear system delivers a tool free installation, Which make a dramatic installation costing saving for every client . The tool free installation be reflected in trunk rail connection , one times AC power connection by start unit and easy installation on the modules .
- > The elegant and special design , Fantastic lighting solution ,High technical function modules , All above advantages make the BRIGHTON trunk linear system popular and hot selling , but also effectively enhance the client' s brand image.

Key Features:

- > Various modules
- > Tool Free installation
- > Max 200 meters multiple link
- > 3-phase AC power source
- > 5/7/11 wiring system
- > Tri-color :3000/5000 mixed 4000K
- > Various functions :
 - 1-10V /DALI / Micro-wave sensor /
 - PIR sensor / 3h emergency

Applications:

- > Commercial lighting applications :
 - Supermarkets , Shopping malls , Airports
 - Stations, Cap parks etc
- > Office lighting applications :
 - Offices , Conference rooms, Showrooms
 - Class rooms , librarys etc
- > Industrial lighting applications
 - Factories, Warehouses, Workshops



Explosion drawing

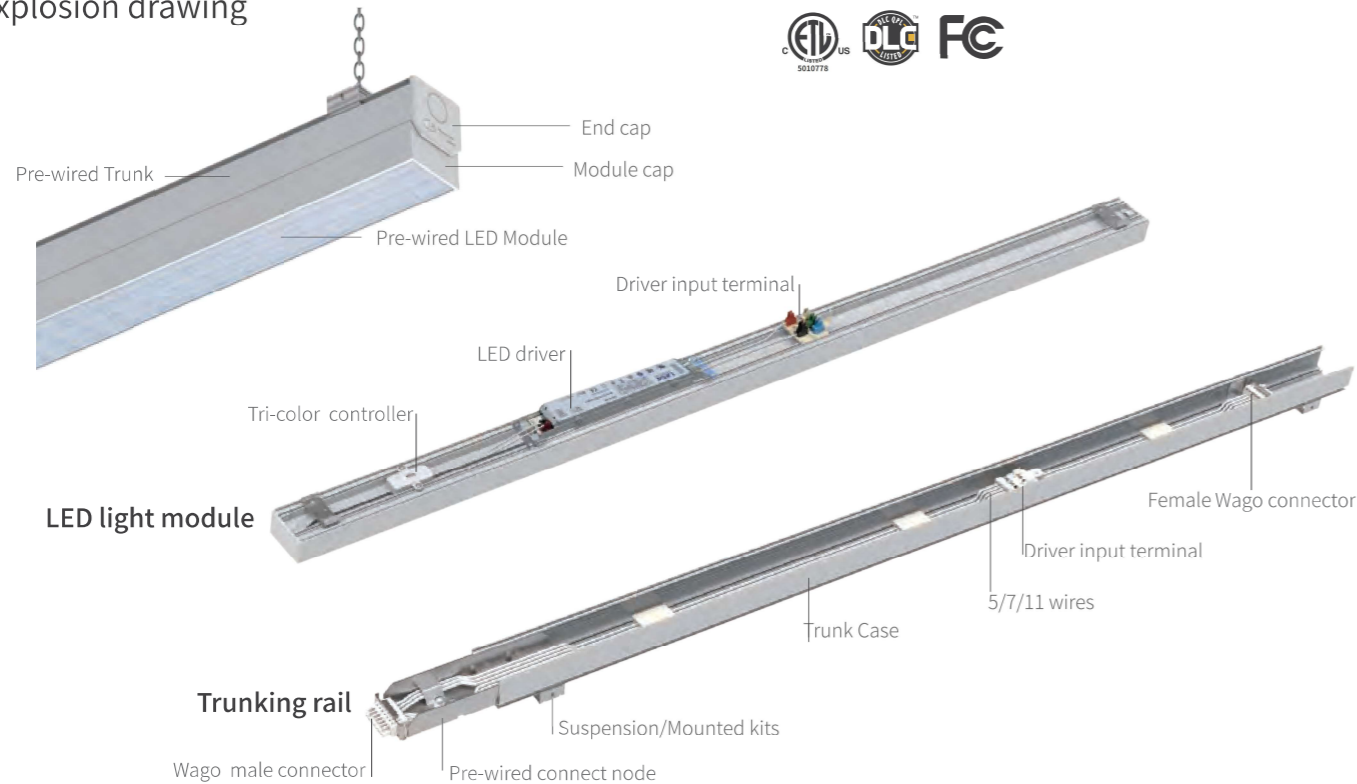

Trunking Rail

BRIGHTON trunk rails are pre-wired sections .Which provide the AC power and control signals to modules . The trunk rail has 5/7/11 wires style which meet the different modules .The available length are 0.6m, 1.2m, 1.5m, 2.4m, 3.0m. The node connectors with wired WAGO terminal on both sides of the trunk rail not only make the tool free installation but also make the installation directions .



Dimensions

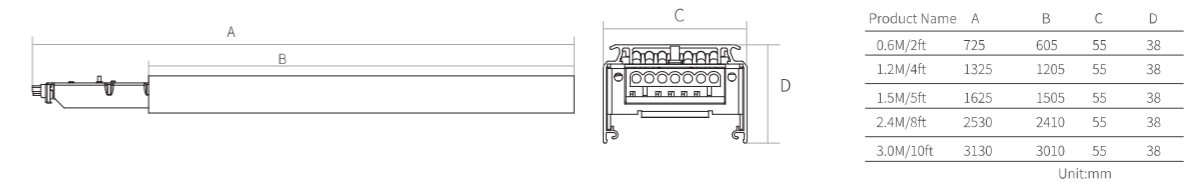

Data sheet

Product name	Item No.	Dimension (L x W x H mm)	Wires	Suitable for
0.6M/2ft Trunking rail	TS-TN06-05-F1	605 x 55 x 38mm	5	3-Phase operation + Basic ON-OFF
	TS-TN06-07-F2		7	3-Phase operation + Basic ON-OFF + Dimming or Emergency
	TS-TN06-11-F3		11	3-Phase operation + Basic ON-OFF + Dimming + Emergency
1.2M/4ft Trunking rail	TS-TN12-05-F1	1205 x 55 x 38mm	5	3-Phase operation + Basic ON-OFF
	TS-TN12-07-F2		7	3-Phase operation + Basic ON-OFF + Dimming or Emergency
	TS-TN12-11-F3		11	3-Phase operation + Basic ON-OFF + Dimming + Emergency
2.4M/8ft Trunking rail	TS-TN24-05-F1	2410 x 55 x 38mm	5	3-Phase operation + Basic ON-OFF
	TS-TN24-07-F2		7	3-Phase operation + Basic ON-OFF + Dimming or Emergency
	TS-TN24-11-F3		11	3-Phase operation + Basic ON-OFF + Dimming + Emergency
1.5M/5ft Trunking rail	TS-TN15-05-F1	1505 x 55 x 38mm	5	3-Phase operation + Basic ON-OFF
	TS-TN15-07-F2		7	3-Phase operation + Basic ON-OFF + Dimming or Emergency
	TS-TN15-11-F3		11	3-Phase operation + Basic ON-OFF + Dimming + Emergency
3.0M/10ft Trunking rail	TS-TN30-05-F1	3010 x 55 x 38mm	5	3-Phase operation + Basic ON-OFF
	TS-TN30-07-F2		7	3-Phase operation + Basic ON-OFF + Dimming or Emergency
	TS-TN30-11-F3		11	3-Phase operation + Basic ON-OFF + Dimming + Emergency

(Dimming : 1-10V / DALI / MS / PIR sensor)

Installation

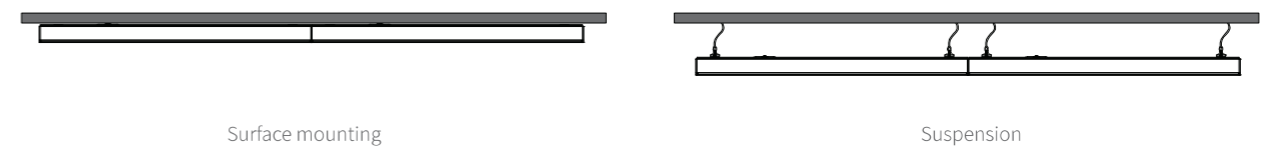

Wiring System

BRIGHTON trunk linear system delivers a very professional wiring system. The trunk rail has the 5/7/11 wiring. The WAGO connector used in the trunk offer a tool free installation between the trunk rails and modules.

BRIGHTON trunk linear not only use the 3-phase & 2.5M (20AWG) power wires but also use the WAGO phase conversion function connector. It allows MAX 16A and 200 meters trunk rail be connected in 3 phase power supply system.

Wire Diagram

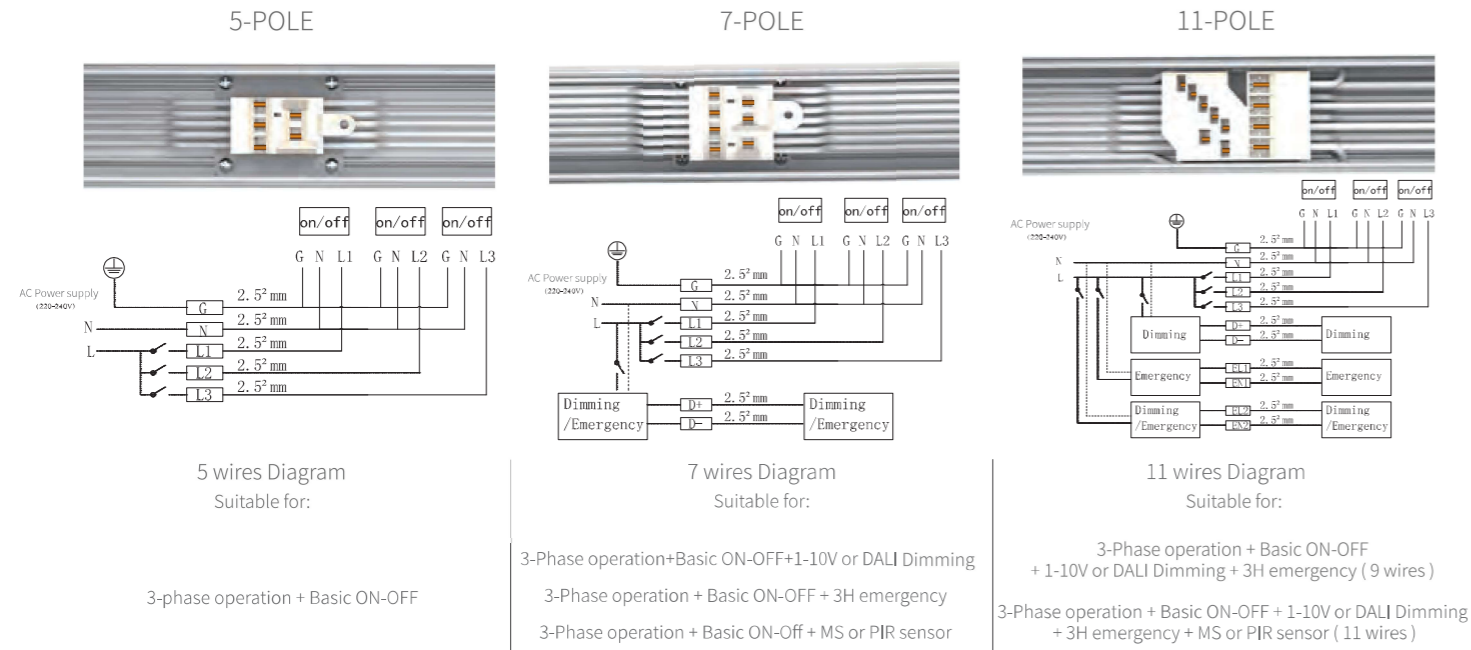

Start Unit

BRIGHTON start units make the trunk linear system just need one time AC power supply connection for each loop. It can be inserted at the beginning or ending of the multiple link. This design makes the saves clients much installation labour cost.

The start unit with the female WAGO AC connection terminal, Just need easy inserting to the trunk rail to finish the installation. It delivers 5/7/11 wires style to meet the different wire style trunk rail.

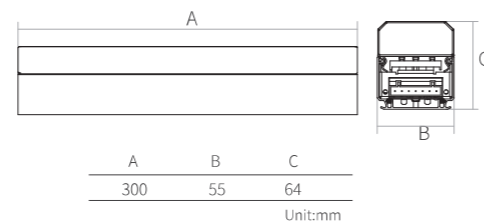

Datasheet

Product name	Item No.	Specification
5 wires Start unit	TS-FM03-05-ST	For 5 wires system
7 wires Start unit	TS-FM03-07-ST	For 7 wires system
11 wires Start unit	TS-FM03-11-ST	For 11 wires system

LED light module : Lens module

Product Picture	Product Name	Order Code	Function	AC Input	LM/W	Lumen Output	CRI	PF THD	Beam Angle	Flicker Free	CCT
	0.6M/2ft/12W lens module	TS-LM06-12PN1-AL001 TS-LM06-12PN1-AL002 TS-LM06-12PN1-AL003	ON/OFF 1-10V DALI	AC200-240V OR AC100-277V	typ.130	typ.1550	>80	>0.95 <15%	30/60/90 LR/25	Y	Single color or Tri-color
	0.6M/2ft/24W lens module	TS-LM06-24RN1-AL001 TS-LM06-24RN1-AL002 TS-LM06-24RN1-AL003	ON/OFF 1-10V DALI	AC200-240V OR AC100-277V	typ.150	typ.3600	>80	>0.95 <15%	30/60/90 LR/25	Y	Single color or Tri-color
	1.2M/4ft/25W lens module	TS-LM12-25PN1-AL001 TS-LM12-25PN1-AL002 TS-LM12-25PN1-AL003	ON/OFF 1-10V DALI	AC200-240V OR AC100-277V	typ.130	typ.3250	>80	>0.95 <15%	30/60/90 LR/25	Y	Single color or Tri-color
	1.2M/4ft/50W lens module	TS-LM12-50RN1-AL001 TS-LM12-50RN1-AL002 TS-LM12-50RN1-AL003	ON/OFF 1-10V DALI	AC200-240V OR AC100-277V	typ.150	typ.7500	>80	>0.95 <15%	30/60/90 LR/25	Y	Single color or Tri-color
	1.5M/5ft/32W lens module	TS-LM15-32PN1-AL001 TS-LM15-32PN1-AL002 TS-LM15-32PN1-AL003	ON/OFF 1-10V DALI	AC200-240V OR AC100-277V	typ.130	typ.4150	>80	>0.95 <15%	30/60/90 LR/25	Y	Single color or Tri-color
	1.5M/5ft/64W lens module	TS-LM15-64RN1-AL001 TS-LM15-64RN1-AL002 TS-LM15-64RN1-AL003	ON/OFF 1-10V DALI	AC200-240V OR AC100-277V	typ.150	typ.9600	>80	>0.95 <15%	30/60/90 LR/25	Y	Single color or Tri-color

LED light module : Gentle module

Product Picture	Product Name	Order Code	Function	AC Input	LM/W	Lumen Output	CRI	PF THD	Beam Angle	Flicker Free	CCT
	0.6M/2ft/12W gentle module	TS-LM06-12SN1-AG001 TS-LM06-12SN1-AG002 TS-LM06-12SN1-AG003	ON/OFF 1-10V DALI	AC200-240V OR AC100-277V	typ.100	typ.1200	>80	>0.95 <15%	120	Y	Single color or Tri-color
	0.6M/2ft/24W gentle module	TS-LM06-24SN1-AG001 TS-LM06-24SN1-AG002 TS-LM06-24SN1-AG003	ON/OFF 1-10V DALI	AC200-240V OR AC100-277V	typ.100	typ.2400	>80	>0.95 <15%	120	Y	Single color or Tri-color
	1.2M/4ft/25W gentle module	TS-LM12-25SN1-AG001 TS-LM12-25SN1-AG002 TS-LM12-25SN1-AG003	ON/OFF 1-10V DALI	AC200-240V OR AC100-277V	typ.100	typ.2500	>80	>0.95 <15%	120	Y	Single color or Tri-color
	1.2M/4ft/50W gentle module	TS-LM12-50SN1-AG001 TS-LM12-50SN1-AG002 TS-LM12-50SN1-AG003	ON/OFF 1-10V DALI	AC200-240V OR AC100-277V	typ.100	typ.5000	>80	>0.95 <15%	120	Y	Single color or Tri-color
	1.5M/5ft/32W gentle module	TS-LM15-32SN1-AG001 TS-LM15-32SN1-AG002 TS-LM15-32SN1-AG003	ON/OFF 1-10V DALI	AC200-240V OR AC100-277V	typ.100	typ.3200	>80	>0.95 <15%	120	Y	Single color or Tri-color
	1.5M/5ft/64W gentle module	TS-LM15-64SN1-AG001 TS-LM15-64SN1-AG002 TS-LM15-64SN1-AG003	ON/OFF 1-10V DALI	AC200-240V OR AC100-277V	typ.100	typ.6400	>80	>0.95 <15%	120	Y	Single color or Tri-color

LED light module : Frosted module

Product Picture	Product Name	Order Code	Function	AC Input	LM/W	Lumen Output	CRI	PF THD	Beam Angle	Flicker Free	CCT
	0.6M/2ft/12W frosted module	TS-LM06-12PN1-AF001 TS-LM06-12PN1-AF002 TS-LM06-12PN1-AF003	ON/OFF 1-10V DALI	AC200-240V OR AC100-277V	typ.120	typ.1450	>80	>0.95 <15%	120	Y	Single color or Tri-color
	0.6M/2ft/24W frosted module	TS-LM06-24PN1-AF001 TS-LM06-24PN1-AF002 TS-LM06-24PN1-AF003	ON/OFF 1-10V DALI	AC200-240V OR AC100-277V	typ.120	typ.2900	>80	>0.95 <15%	120	Y	Single color or Tri-color
	1.2M/4ft/25W frosted module	TS-LM12-25PN1-AF001 TS-LM12-25PN1-AF002 TS-LM12-25PN1-AF003	ON/OFF 1-10V DALI	AC200-240V OR AC100-277V	typ.120	typ.3000	>80	>0.95 <15%	120	Y	Single color or Tri-color
	1.2M/4ft/50W frosted module	TS-LM12-50PN1-AF001 TS-LM12-50PN1-AF002 TS-LM12-50PN1-AF003	ON/OFF 1-10V DALI	AC200-240V OR AC100-277V	typ.120	typ.6000	>80	>0.95 <15%	120	Y	Single color or Tri-color
	1.5M/5ft/32W frosted module	TS-LM15-32PN1-AF001 TS-LM15-32PN1-AF002 TS-LM15-32PN1-AF003	ON/OFF 1-10V DALI	AC200-240V OR AC100-277V	typ.120	typ.3850	>80	>0.95 <15%	120	Y	Single color or Tri-color
	1.5M/5ft/64W frosted module	TS-LM15-64PN1-AF001 TS-LM15-64PN1-AF002 TS-LM15-64PN1-AF003	ON/OFF 1-10V DALI	AC200-240V OR AC100-277V	typ.120	typ.7650	>80	>0.95 <15%	120	Y	Single color or Tri-color

LED light module : Narrow module

Product Picture	Product Name	Order Code	Function	AC Input	LM/W	Lumen Output	CRI	PF THD	Beam Angle	Flicker Free	CCT
	0.6M/2ft/12W narrow module	TS-LM06-12PN1-AN001 TS-LM06-12PN1-AN002 TS-LM06-12PN1-AN003	ON/OFF 1-10V DALI	AC200-240V OR AC100-277V	typ.130	typ.1550	>80	>0.95 <15%	80	Y	Single color or Tri-color
	0.6M/2ft/24W narrow module	TS-LM06-24RN1-AN001 TS-LM06-24RN1-AN002 TS-LM06-24RN1-AN003	ON/OFF 1-10V DALI	AC200-240V OR AC100-277V	typ.150	typ.3600	>80	>0.95 <15%	80	Y	Single color or Tri-color
	1.2M/4ft/25W narrow module	TS-LM12-25PN1-AN001 TS-LM12-25PN1-AN002 TS-LM12-25PN1-AN003	ON/OFF 1-10V DALI	AC200-240V OR AC100-277V	typ.130	typ.3250	>80	>0.95 <15%	80	Y	Single color or Tri-color
	1.2M/4ft/50W narrow module	TS-LM12-50RN1-AN001 TS-LM12-50RN1-AN002 TS-LM12-50RN1-AN003	ON/OFF 1-10V DALI	AC200-240V OR AC100-277V	typ.150	typ.7500	>80	>0.95 <15%	80	Y	Single color or Tri-color
	1.5M/5ft/32W narrow module	TS-LM15-32PN1-AN001 TS-LM15-32PN1-AN002 TS-LM15-32PN1-AN003	ON/OFF 1-10V DALI	AC200-240V OR AC100-277V	typ.130	typ.4150	>80	>0.95 <15%	80	Y	Single color or Tri-color
	1.5M/5ft/64W narrow module	TS-LM15-64RN1-AN001 TS-LM15-64RN1-AN002 TS-LM15-64RN1-AN003	ON/OFF 1-10V DALI	AC200-240V OR AC100-277V	typ.150	typ.9600	>80	>0.95 <15%	80	Y	Single color or Tri-color

LED light module : T8 module

Product Picture	Product Name	Order Code	Function	AC Input	LM/W	Lumen Output	CRI	PF THD	Beam Angle	Flicker Free	CCT
	0.6M/2ft/12W T8 module	TS-LM06-12PN1-AT001 TS-LM06-12PN1-AT002 TS-LM06-12PN1-AT003	ON/OFF 1-10V DALI	AC200-240V OR AC100-277V	typ.120	typ.1450	>80	>0.95 <15%	120	Y	Single color or Tri-color
	0.6M/2ft/24W T8 module	TS-LM06-24PN1-AT001 TS-LM06-24PN1-AT002 TS-LM06-24PN1-AT003	ON/OFF 1-10V DALI	AC200-240V OR AC100-277V	typ.120	typ.2900	>80	>0.95 <15%	120	Y	Single color or Tri-color
	1.2M/4ft/25W T8 module	TS-LM12-25PN1-AT001 TS-LM12-25PN1-AT002 TS-LM12-25PN1-AT003	ON/OFF 1-10V DALI	AC200-240V OR AC100-277V	typ.120	typ.3000	>80	>0.95 <15%	120	Y	Single color or Tri-color
	1.2M/4ft/50W T8 module	TS-LM12-50PN1-AT001 TS-LM12-50PN1-AT002 TS-LM12-50PN1-AT003	ON/OFF 1-10V DALI	AC200-240V OR AC100-277V	typ.120	typ.6000	>80	>0.95 <15%	120	Y	Single color or Tri-color
	1.5M/5ft/32W T8 module	TS-LM15-32PN1-AT001 TS-LM15-32PN1-AT002 TS-LM15-32PN1-AT003	ON/OFF 1-10V DALI	AC200-240V OR AC100-277V	typ.120	typ.3850	>80	>0.95 <15%	120	Y	Single color or Tri-color
	1.5M/5ft/64W T8 module	TS-LM15-64PN1-AT001 TS-LM15-64PN1-AT002 TS-LM15-64PN1-AT003	ON/OFF 1-10V DALI	AC200-240V OR AC100-277V	typ.120	typ.7650	>80	>0.95 <15%	120	Y	Single color or Tri-color

Function Module: : Track Rail

Product Picture	Product Name	Order Code	Dimension																		
	1.2M/Track Rail	TS-FM12-05-TR	<table border="1"> <thead> <tr> <th>Product Name</th> <th>A</th> <th>B</th> <th>C</th> <th>D</th> <th>E</th> </tr> </thead> <tbody> <tr> <td>1.2M/4ft</td> <td>1205</td> <td>700</td> <td>55</td> <td>26</td> <td>54</td> </tr> <tr> <td>1.5M/5ft</td> <td>1505</td> <td>1000</td> <td>55</td> <td>26</td> <td>54</td> </tr> </tbody> </table>	Product Name	A	B	C	D	E	1.2M/4ft	1205	700	55	26	54	1.5M/5ft	1505	1000	55	26	54
	Product Name	A		B	C	D	E														
1.2M/4ft	1205	700	55	26	54																
1.5M/5ft	1505	1000	55	26	54																
	1.5M/Track Rail	TS-FM15-05-TR																			

Function Module: : Blank Cover

Product Picture	Product Name	Order Code	Dimension																				
	0.6M/Blank Cover	TS-FM06-BC	<table border="1"> <thead> <tr> <th>Product Name</th> <th>A</th> <th>B</th> <th>C</th> <th>D</th> </tr> </thead> <tbody> <tr> <td>0.6M/2ft</td> <td>605</td> <td>55</td> <td>26</td> <td>54</td> </tr> <tr> <td>1.2M/4ft</td> <td>1205</td> <td>55</td> <td>26</td> <td>54</td> </tr> <tr> <td>1.5M/5ft</td> <td>1505</td> <td>55</td> <td>26</td> <td>54</td> </tr> </tbody> </table>	Product Name	A	B	C	D	0.6M/2ft	605	55	26	54	1.2M/4ft	1205	55	26	54	1.5M/5ft	1505	55	26	54
	Product Name	A		B	C	D																	
	0.6M/2ft	605		55	26	54																	
1.2M/4ft	1205	55	26	54																			
1.5M/5ft	1505	55	26	54																			
	1.2M/Blank Cover	TS-FM12-BC																					
	1.5M/Blank Cover	TS-FM15-BC																					

Function Module: Micro-wave sensor module

Product Picture	Order Code	Detection Pattern(max/min)	Specification
	TS-FM07-07-MS		Rated Power: 400W(fluorescent 5E3), 800W(incandescent 2E4) Operating Voltage: 220~240V Detection Area(Radius):6m Max. Max.Mounting height:6m Hold time:5s/30s/90s/3min/20min/30min Operating temperature:-25°C~60°C

Function Module: PIR Sensor module

Product Picture	Order Code	Detection Pattern(max/min)	Specification
	TS-FM07-07-PR		Rated Power:200W Operating Voltage: 220~240V Detection Area(Radius):6m Max. Max.Mounting height:6m Hold time:30s~30min Operating temperature:-25°C~60°C

Function Module: Emergency module

Product Picture	Order Code	Battery pack	Specification
	TS-FM07-07-EM		Rated Power:3/6W Operating Voltage: 200~240V LED Voltage:25~48V DC Emergency time:3h Lumen output : 10% @ led light module Operating temperature:-25°C~60°C

Accessories

Left connector	Right connector	T connector	X connector
Suspension kits	Wire connector	End cap	Waterproof cap



LED Track Panel

60%
energy saving

50,000
hours life

5 years
warranty

LED Track Panel

Track Panel : Wattage adjustable , 1-10V /DALI Dimming



Wattage adjustable
1~10V dimming
5 YR

Tri-color
3000K 4000K 5000K

Features

- > 30/60/90/L25/R25 viewing angle
- > Wattage adjustable
- > Single or Tri-Color
- > 5 years warranty

Applications

- > Replacement for Normal Track Light,
- > Warehouses , Factories, Supermarkets

Options

- > Viewing angle:
30/60/90/Double25 viewing angle
- > Emitting color :
Single or Tri-color
- > Function :
ON-OFF / 1-10V/DALI
- > Wattage Adjustable:
32W / 64W / 32-64W
- > Installation : T
Track / Suspension

EU Style



Order Code	Product Name	Rated Power	Lumen Output	Lumen Efficacy	Color Index	AC Input	Power Factor	Flicker Free
Single Color								
TK60-32DN1-ALN1B-001	600x150mm-32W GS track panel	32W	4450LM	140LM/W	Ra>80	AC200-240V	PF>0.95	Y
TK60-64DN1-ALN1B-001	600x150mm-64W GS track panel	64W	8950LM	140LM/W	Ra>80	AC200-240V	PF>0.95	Y
Tri-color								
TK60-32DTR-ALN1B-001	600x150mm-32W GS track panel	32W	4450LM	140LM/W	Ra>80	AC200-240V	PF>0.95	Y
TK60-64DTR-ALN1B-001	600x150mm-64W GS track panel	64W	8950LM	140LM/W	Ra>80	AC200-240V	PF>0.95	Y

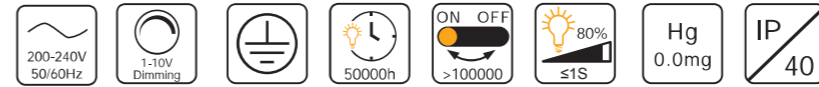

North American Style: 1-10V dimming as standard



Order Code	Product Name	Rated Power	Lumen Output	Lumen Efficacy	Color Index	AC Input	Power Factor	Flicker Free
Single Color								
TK60-32DN1-ALV1X-500	600x150mm-32W ETL track panel	32W	4450LM	140LM/W	Ra>80	AC100-277V	PF>0.95	Y
TK60-60DN1-ALV1X-500	600x150mm-64W ETL track panel	60W	8400LM	140LM/W	Ra>80	AC100-277V	PF>0.95	Y
Tri-color								
TK60-32DN1-ALV1X-500	600x150mm-32W ETL track panel	32W	4450LM	140LM/W	Ra>80	AC100-277V	PF>0.95	Y
TK60-60DN1-ALV1X-500	600x150mm-60W ETL track panel	60W	8400LM	100LM/W	Ra>80	AC100-277V	PF>0.95	Y



Dimensions

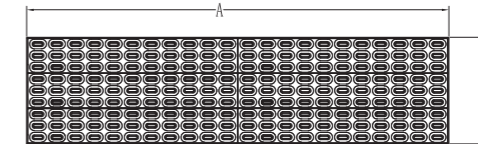
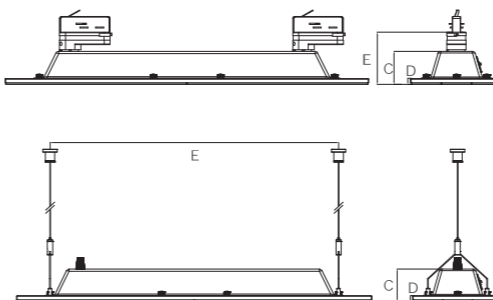

Product Name	A	B	C	D	E
Track	602	152	55	9	80
Suspension	602	152	55	9	486

Unit: mm



LED Linear Light LED Batten Light

60%
energy saving

50,000
hours life

5 years
warranty

LED Linear Light : T8 Slim Batten

T8 Slim Batten 120LM/W GS /ETL /DLC approval



EU Style



Order Code	Product Name	Rated Power	Lumen Output	Lumen Efficacy	Color Index	AC Input	Dimming	Power Factor	Flicker Free
Single Color Series									
BT02-10PN1-STN2B-001	60CM-10W GS T8 slim batten	10W	1200LM	120LM/W	Ra>80	AC200-240V	ON/OFF	PF>0.95	N
BT04-17PN1-STN2B-001	120CM-17W GS T8 slim batten	17W	2050LM	120LM/W	Ra>80	AC200-240V	ON/OFF	PF>0.95	N
BT04-32PN1-STN2B-001	120CM-32W GS T8 slim batten	32W	3850LM	120LM/W	Ra>80	AC200-240V	ON/OFF	PF>0.95	N
BT05-28PN1-STN2B-001	150CM-28W GS T8 slim batten	28W	3350LM	120LM/W	Ra>80	AC200-240V	ON/OFF	PF>0.95	N
BT05-56PN1-STN2B-001	150CM-56W GS T8 slim batten	56W	6700LM	120LM/W	Ra>80	AC200-240V	ON/OFF	PF>0.95	N
BT06-32PN1-STN2B-001	180CM-32W GS T8 slim batten	32W	3850LM	120LM/W	Ra>80	AC200-240V	ON/OFF	PF>0.95	N
BT06-62PN1-STN2B-001	180CM-62W GS T8 slim batten	62W	7500LM	120LM/W	Ra>80	AC200-240V	ON/OFF	PF>0.95	N
Tri-color Series									
BT02-10PTR-STN2B-001	60CM-10W GS T8 slim batten	10W	1200LM	120LM/W	Ra>80	AC200-240V	ON/OFF	PF>0.95	N
BT04-17PTR-STN2B-001	120CM-17W GS T8 slim batten	17W	2050LM	120LM/W	Ra>80	AC200-240V	ON/OFF	PF>0.95	N
BT04-32PTR-STN2B-001	120CM-32W GS T8 slim batten	32W	3850LM	120LM/W	Ra>80	AC200-240V	ON/OFF	PF>0.95	N
BT05-28PTR-STN2B-001	150CM-28W GS T8 slim batten	28W	3350LM	120LM/W	Ra>80	AC200-240V	ON/OFF	PF>0.95	N
BT05-56PTR-STN2B-001	150CM-56W GS T8 slim batten	56W	6700LM	120LM/W	Ra>80	AC200-240V	ON/OFF	PF>0.95	N
BT06-32PTR-STN2B-001	180CM-32W GS T8 slim batten	32W	3850LM	120LM/W	Ra>80	AC200-240V	ON/OFF	PF>0.95	N
BT06-62PTR-STN2B-001	180CM-62W GS T8 slim batten	62W	7500LM	120LM/W	Ra>80	AC200-240V	ON/OFF	PF>0.95	N



North American Style : 1-10V Dimming as standard



Order Code	Product Name	Rated Power	Lumen Output	Lumen Efficacy	Color Index	AC Input	Dimming	Power Factor	Flicker Free
Single Color Series									
BT02-10PN1-STV1X-500	2ft-10W ETL T8 slim batten	10W	1200LM	120LM/W	Ra>80	AC100-277V	1-10V	PF>0.95	Y
BT04-17PN1-STV1X-500	4ft-17W ETL T8 slim batten	17W	2050LM	120LM/W	Ra>80	AC100-277V	1-10V	PF>0.95	Y
BT04-32PN1-STV1X-500	4ft-32W ETL T8 slim batten	32W	3850LM	120LM/W	Ra>80	AC100-277V	1-10V	PF>0.95	Y
BT05-28PN1-STV1X-500	5ft-28W ETL T8 slim batten	28W	3350LM	120LM/W	Ra>80	AC100-277V	1-10V	PF>0.95	Y
BT05-56PN1-STV1X-500	5ft-56W ETL T8 slim batten	56W	6700LM	120LM/W	Ra>80	AC100-277V	1-10V	PF>0.95	Y
BT06-32PN1-STV1X-500	6ft-32W ETL T8 slim batten	32W	3850LM	120LM/W	Ra>80	AC100-277V	1-10V	PF>0.95	Y
BT06-62PN1-STV1X-500	6ft-62W ETL T8 slim batten	62W	7500LM	120LM/W	Ra>80	AC100-277V	1-10V	PF>0.95	Y
Tri-color Series									
BT02-10PTR-STV1X-500	2ft-10W ETL T8 slim batten	10W	1200LM	120LM/W	Ra>80	AC100-277V	1-10V	PF>0.95	Y
BT04-17PTR-STV1X-500	4ft-17W ETL T8 slim batten	17W	2050LM	120LM/W	Ra>80	AC100-277V	1-10V	PF>0.95	Y
BT04-32PTR-STV1X-500	4ft-32W ETL T8 slim batten	32W	3850LM	120LM/W	Ra>80	AC100-277V	1-10V	PF>0.95	Y
BT05-28PTR-STV1X-500	5ft-28W ETL T8 slim batten	28W	3350LM	120LM/W	Ra>80	AC100-277V	1-10V	PF>0.95	Y
BT05-56PTR-STV1X-500	5ft-56W ETL T8 slim batten	56W	6700LM	120LM/W	Ra>80	AC100-277V	1-10V	PF>0.95	Y
BT06-32PTR-STV1X-500	6ft-32W ETL T8 slim batten	32W	3850LM	120LM/W	Ra>80	AC100-277V	1-10V	PF>0.95	Y
BT06-62PTR-STV1X-500	6ft-62W ETL T8 slim batten	62W	7500LM	120LM/W	Ra>80	AC100-277V	1-10V	PF>0.95	Y

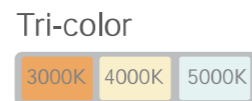

Features

- > Patent design for T8 fluorescent fitting
- > End or rear cable entry
- > Easy installation
- > 5 years warranty

Applications

- > Replacement for T8 /T5 fluorescent batten
- > Warehouses , Factories, Car parks , Supermarket
- > Stations, Office

Options

- > Emitting color : Single or Tri-color
- > Dimming : on-off / 1-10V / DALI/PIR
- > Wiring method : Single or double sides
- > Installation : Surface mounting or Suspension

Dimensions

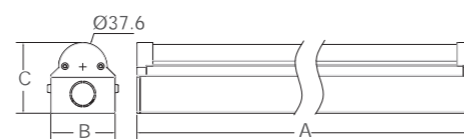

Product Name	A	B	C
60cm/2ft	600	55	58
120cm/4ft	1200	55	58
150cm/5ft	1500	55	58
180cm/6ft	1800	55	58

Unit:mm

LED Linear Light : Narrow Slim Batten

Narrow Slim Batten : 80 Degree 120LM/W High Lux GS /ETL/DLC Approval



EU Style



Order Code	Product Name	Rated Power	Lumen Output	Lumen Efficacy	Color Index	AC Input	Dimming	Power Factor	Flicker Free
Single Color Series									
BT04-17PN1-SNN2B-001	120CM-17W GS narrow slim batten	17W	2050LM	120LM/W	Ra>80	AC200-240V	ON/OFF	PF>0.95	N
BT04-32PN1-SNN2B-001	120CM-32W GS narrow slim batten	32W	3850LM	120LM/W	Ra>80	AC200-240V	ON/OFF	PF>0.95	N
BT05-28PN1-SNN2B-001	150CM-28W GS narrow slim batten	28W	3350LM	120LM/W	Ra>80	AC200-240V	ON/OFF	PF>0.95	N
BT05-56PN1-SNN2B-001	150CM-56W GS narrow slim batten	56W	6700LM	120LM/W	Ra>80	AC200-240V	ON/OFF	PF>0.95	N
BT06-32PN1-SNN2B-001	180CM-32W GS narrow slim batten	32W	3850LM	120LM/W	Ra>80	AC200-240V	ON/OFF	PF>0.95	N
BT06-62PN1-SNN2B-001	180CM-62W GS narrow slim batten	62W	7500LM	120LM/W	Ra>80	AC200-240V	ON/OFF	PF>0.95	N
BT06-72PN1-SNN2B-001	180CM-72W GS narrow slim batten	72W	8650LM	120LM/W	Ra>80	AC200-240V	ON/OFF	PF>0.95	N
Tri-color Series									
BT04-17PTR-SNN2B-001	120CM-17W GS narrow slim batten	17W	2050LM	120LM/W	Ra>80	AC200-240V	ON/OFF	PF>0.95	N
BT04-32PTR-SNN2B-001	120CM-32W GS narrow slim batten	32W	3850LM	120LM/W	Ra>80	AC200-240V	ON/OFF	PF>0.95	N
BT05-28PTR-SNN2B-001	150CM-28W GS narrow slim batten	28W	3350LM	120LM/W	Ra>80	AC200-240V	ON/OFF	PF>0.95	N
BT05-56PTR-SNN2B-001	150CM-56W GS narrow slim batten	56W	6700LM	120LM/W	Ra>80	AC200-240V	ON/OFF	PF>0.95	N
BT06-32PTR-SNN2B-001	180CM-32W GS narrow slim batten	32W	3850LM	120LM/W	Ra>80	AC200-240V	ON/OFF	PF>0.95	N
BT06-62PTR-SN N2B-001	180CM-62W GS narrow slim batten	62W	7500LM	120LM/W	Ra>80	AC200-240V	ON/OFF	PF>0.95	N
BT06-72PN1-SNN2B-001	180CM-72W GS narrow slim batten	72W	8650LM	120LM/W	Ra>80	AC200-240V	ON/OFF	PF>0.95	N



North American Style : 1-10V Dimming as standard



Order Code	Product Name	Rated Power	Lumen Output	Lumen Efficacy	Color Index	AC Input	Dimming	Power Factor	Flicker Free
Single Color Series									
BT04-17PN1-SNV1X-500	4ft-17W ETL narrow slim batten	17W	2050LM	120LM/W	Ra>80	AC100-277V	1-10V	PF>0.95	Y
BT04-32PN1-SNV1X-500	4ft-32W ETL narrow slim batten	32W	3850LM	120LM/W	Ra>80	AC100-277V	1-10V	PF>0.95	Y
BT05-28PN1-SNV1X-500	5ft-28W ETL narrow slim batten	28W	3350LM	120LM/W	Ra>80	AC100-277V	1-10V	PF>0.95	Y
BT05-56PN1-SNV1X-500	5ft-56W ETL narrow slim batten	56W	6700LM	120LM/W	Ra>80	AC100-277V	1-10V	PF>0.95	Y
BT06-32PN1-SNV1X-500	6ft-32W ETL narrow slim batten	32W	3850LM	120LM/W	Ra>80	AC100-277V	1-10V	PF>0.95	Y
BT06-62PN1-SNV1X-500	6ft-62W ETL narrow slim batten	62W	7500LM	120LM/W	Ra>80	AC100-277V	1-10V	PF>0.95	Y
BT06-72PN1-SNV1X-500	6ft-72W ETL narrow slim batten	72W	8650LM	120LM/W	Ra>80	AC100-277V	1-10V	PF>0.95	Y
Tri-color Series									
BT04-17PTR-SNV1X-500	4ft-17W ETL narrow slim batten	17W	2050LM	120LM/W	Ra>80	AC100-277V	1-10V	PF>0.95	Y
BT04-32PTR-SNV1X-500	4ft-32W ETL narrow slim batten	32W	3850LM	120LM/W	Ra>80	AC100-277V	1-10V	PF>0.95	Y
BT05-28PTR-SNV1X-500	5ft-28W ETL narrow slim batten	28W	3350LM	120LM/W	Ra>80	AC100-277V	1-10V	PF>0.95	Y
BT05-56PTR-SNV1X-500	5ft-56W ETL narrow slim batten	56W	6700LM	120LM/W	Ra>80	AC100-277V	1-10V	PF>0.95	Y
BT06-32PTR-SNV1X-500	6ft-32W ETL narrow slim batten	32W	3850LM	120LM/W	Ra>80	AC100-277V	1-10V	PF>0.95	Y
BT06-62PTR-SNV1X-500	6ft-62W ETL narrow slim batten	62W	7500LM	120LM/W	Ra>80	AC100-277V	1-10V	PF>0.95	Y
BT06-72PTR-SNV1X-500	6ft-72W ETL narrow slim batten	72W	8650LM	120LM/W	Ra>80	AC100-277V	1-10V	PF>0.95	Y



80
degree

1~10V
dimming

5 YR

Tri-color

3000K

4000K

5000K

Features

- > Patent design for T8 fluorescent fitting
- > End or rear cable entry
- > 80 degree with higher Lux
- > Easy installation
- > 5 years warranty

Applications

- > Replacement for T8 /T5 fluorescent batten
- > Warehouses , Factories, Car parks , Supermarket
- > Stations, Office

Options

- > Emitting color : Single or Tri-color
- > Dimming : on-off / 1-10V / DALI
- > Wiring method : Single or double sides
- > Installation : Surface mounting or Suspension

Dimensions

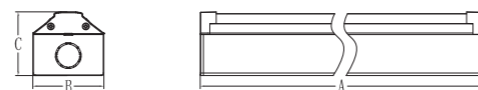

Product Name	A	B	C
60cm/2ft	584	55	50
120cm/4ft	1154	55	50
150cm/5ft	1439	55	50
180cm/6ft	1724	55	50

Unit:mm

LED Linear Light : Gentle Slim Batten

Gentle Slim Batten : Low Glare /UGR<19 100LM/W GS /ETL/DLC Approval

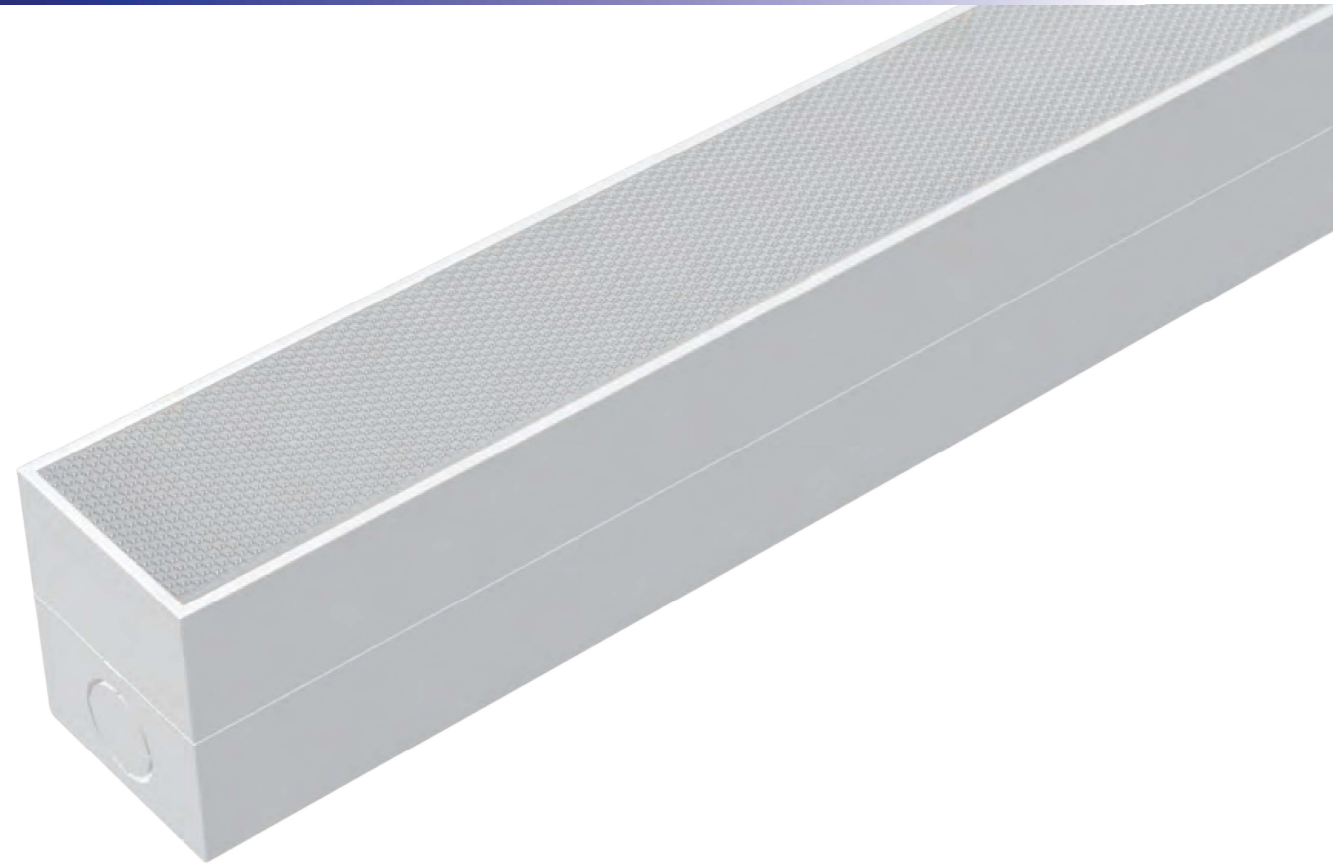

EU Style



• Data Sheet

Order Code	Product Name	Rated Power	Lumen Output	Lumen Efficacy	Color Index	AC Input	UGR	Power Factor	Flicker Free
Single Color Series									
BT02-10SN1-SGN1B-001	60CM-10W GS gentle slim batten	10W	1000LM	100LM/W	Ra>80	AC200-240V	<19	PF>0.95	Y
BT04-17SN1-SGN1B-001	120CM-17W GS gentle slim batten	17W	1700LM	100LM/W	Ra>80	AC200-240V	<19	PF>0.95	Y
BT05-28SN1-SGN1B-001	150CM-28W GS gentle slim batten	28W	2800LM	100LM/W	Ra>80	AC200-240V	<19	PF>0.95	Y
BT06-32SN1-SGN1B-001	180CM-32W GS gentle slim batten	32W	3200LM	100LM/W	Ra>80	AC200-240V	<19	PF>0.95	Y
Tri-color Series									
BT02-10STR-SGN1B-001	60CM-10W GS gentle slim batten	10W	1000LM	100LM/W	Ra>80	AC200-240V	<19	PF>0.95	Y
BT04-17STR-SGN1B-001	120CM-17W GS gentle slim batten	17W	1700LM	100LM/W	Ra>80	AC200-240V	<19	PF>0.95	Y
BT05-28STR-SGN1B-001	150CM-28W GS gentle slim batten	28W	2800LM	100LM/W	Ra>80	AC200-240V	<19	PF>0.95	Y
BT06-32STR-SGN1B-001	180CM-32W GS gentle slim batten	32W	3200LM	100LM/W	Ra>80	AC200-240V	<19	PF>0.95	Y



North American Style : 1-10V Dimming as standard



• Data Sheet

Order Code	Product Name	Rated Power	Lumen Output	Lumen Efficacy	Color Index	AC Input	UGR	Power Factor	Flicker Free
Single Color Series									
BT02-10SN1-SGV1X-500	2ft-10W ETL gentle slim batten	10W	1000LM	100LM/W	Ra>80	AC100-277V	<19	PF>0.95	Y
BT04-17SN1-SGV1X-500	4ft-17W ETL gentle slim batten	17W	1700LM	100LM/W	Ra>80	AC100-277V	<19	PF>0.95	Y
BT05-28SN1-SGV1X-500	5ft-28W ETL gentle slim batten	28W	2800LM	100LM/W	Ra>80	AC100-277V	<19	PF>0.95	Y
BT06-32SN1-SGV1X-500	6ft-32W ETL gentle slim batten	32W	3200LM	100LM/W	Ra>80	AC100-277V	<19	PF>0.95	Y
Tri-color Series									
BT02-10STR-SGV1X-500	2ft-10W ETL gentle slim batten	10W	1000LM	100LM/W	Ra>80	AC100-277V	<19	PF>0.95	Y
BT04-17STR-SGV1X-500	4ft-17W ETL gentle slim batten	17W	1700LM	100LM/W	Ra>80	AC100-277V	<19	PF>0.95	Y
BT05-28STR-SGV1X-500	5ft-28W ETL gentle slim batten	28W	2800LM	100LM/W	Ra>80	AC100-277V	<19	PF>0.95	Y
BT06-32STR-SGV1X-500	6ft-32W ETL gentle slim batten	32W	3200LM	100LM/W	Ra>80	AC100-277V	<19	PF>0.95	Y



UGR <19

1~10V dimming

5 YR

Tri-color

3000K

4000K

5000K

Features

- > Low glare /UGR<19
- > End or rear cable entry
- > Easy installation
- > 5 years warranty

Applications

- > Replacement for T8 /T5 fluorescent batten
- > Education light : Classroom
- > Office Light : Office, Conference room
- > Commercial Light : Supermarket , Shoppingmall

Options

- > Emitting color : Single or Tri-color
- > Dimming : on-off / 1-10V / DALI
- > Wiring method : Single or double sides
- > Installation : Surface mounting or Suspension

Dimensions

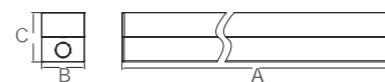

Product Name	A	B	C
60cm/2ft	642	55	63.5
120cm/4ft	1119	55	63.5
150cm/5ft	1473	55	63.5
180cm/6ft	1755	55	63.5

Unit:mm

LED Linear Light : Frosted Slim Batten

Frosted Slim Batten 120LM/W GS/ETL/DLC approval



EU Style



Order Code	Product Name	Rated Power	Lumen Output	Lumen Efficacy	Color Index	AC Input	Dimming	Power Factor	Flicker Free
Single Color Series									
BT02-10PN1-SFN2B-001	60CM-10W GS forsted slim batten	10W	1200LM	120LM/W	Ra>80	AC200-240V	ON/OFF	PF>0.95	N
BT04-17PN1-SFN2B-001	120CM-17W GS forsted slim batten	17W	2050LM	120LM/W	Ra>80	AC200-240V	ON/OFF	PF>0.95	N
BT04-32PN1-SFN2B-001	120CM-32W GS forsted slim batten	32W	3850LM	120LM/W	Ra>80	AC200-240V	ON/OFF	PF>0.95	N
BT05-28PN1-SFN2B-001	150CM-28W GS forsted slim batten	28W	3350LM	120LM/W	Ra>80	AC200-240V	ON/OFF	PF>0.95	N
BT05-56PN1-SFN2B-001	150CM-56W GS forsted slim batten	56W	6700LM	120LM/W	Ra>80	AC200-240V	ON/OFF	PF>0.95	N
BT06-32PN1-SFN2B-001	180CM-32W GS forsted slim batten	32W	3850LM	120LM/W	Ra>80	AC200-240V	ON/OFF	PF>0.95	N
BT06-62PN1-SFN2B-001	180CM-62W GS forsted slim batten	62W	7500LM	120LM/W	Ra>80	AC200-240V	ON/OFF	PF>0.95	N
Tri-color Series									
BT02-10PTR-SFN2B-001	60CM-10W GS forsted slim batten	10W	1200LM	120LM/W	Ra>80	AC200-240V	ON/OFF	PF>0.95	N
BT04-17PTR-SFN2B-001	120CM-17W GS forsted slim batten	17W	2050LM	120LM/W	Ra>80	AC200-240V	ON/OFF	PF>0.95	N
BT04-32PTR-SFN2B-001	120CM-32W GS forsted slim batten	32W	3850LM	120LM/W	Ra>80	AC200-240V	ON/OFF	PF>0.95	N
BT05-28PTR-SFN2B-001	150CM-28W GS forsted slim batten	28W	3350LM	120LM/W	Ra>80	AC200-240V	ON/OFF	PF>0.95	N
BT05-56PTR-SFN2B-001	150CM-56W GS forsted slim batten	56W	6700LM	120LM/W	Ra>80	AC200-240V	ON/OFF	PF>0.95	N
BT06-32PTR-SFN2B-001	180CM-32W GS forsted slim batten	32W	3850LM	120LM/W	Ra>80	AC200-240V	ON/OFF	PF>0.95	N
BT06-62PTR-SFN2B-001	180CM-62W GS forsted slim batten	62W	7500LM	120LM/W	Ra>80	AC200-240V	ON/OFF	PF>0.95	N



North American Style : 1-10V Dimming as standard



Order Code	Product Name	Rated Power	Lumen Output	Lumen Efficacy	Color Index	AC Input	Dimming	Power Factor	Flicker Free
Single Color Series									
BT02-10PN1-SFV1X-500	2ft-10W ETL forsted slim batten	10W	1200LM	120LM/W	Ra>80	AC100-277V	1-10V	PF>0.95	Y
BT04-17PN1-SFV1X-500	4ft-17W ETL forsted slim batten	17W	2050LM	120LM/W	Ra>80	AC100-277V	1-10V	PF>0.95	Y
BT04-32PN1-SFV1X-500	4ft-32W ETL forsted slim batten	32W	3850LM	120LM/W	Ra>80	AC100-277V	1-10V	PF>0.95	Y
BT05-28PN1-SFV1X-500	5ft-28W ETL forsted slim batten	28W	3350LM	120LM/W	Ra>80	AC100-277V	1-10V	PF>0.95	Y
BT05-56PN1-SFV1X-500	5ft-56W ETL forsted slim batten	56W	6700LM	120LM/W	Ra>80	AC100-277V	1-10V	PF>0.95	Y
BT06-32PN1-SFV1X-500	6ft-32W ETL forsted slim batten	32W	3850LM	120LM/W	Ra>80	AC100-277V	1-10V	PF>0.95	Y
BT06-62PN1-SFV1X-500	6ft-62W ETL forsted slim batten	62W	7500LM	120LM/W	Ra>80	AC100-277V	1-10V	PF>0.95	Y
Tri-color Series									
BT02-10PTR-SFV1X-500	2ft-10W ETL forsted slim batten	10W	1200LM	120LM/W	Ra>80	AC100-277V	1-10V	PF>0.95	Y
BT04-17PTR-SFV1X-500	4ft-17W ETL forsted slim batten	17W	2050LM	120LM/W	Ra>80	AC100-277V	1-10V	PF>0.95	Y
BT04-32PTR-SFV1X-500	4ft-32W ETL forsted slim batten	32W	3850LM	120LM/W	Ra>80	AC100-277V	1-10V	PF>0.95	Y
BT05-28PTR-SFV1X-500	5ft-28W ETL forsted slim batten	28W	3350LM	120LM/W	Ra>80	AC100-277V	1-10V	PF>0.95	Y
BT05-56PTR-SFV1X-500	5ft-56W ETL forsted slim batten	56W	6700LM	120LM/W	Ra>80	AC100-277V	1-10V	PF>0.95	Y
BT06-32PTR-SFV1X-500	6ft-32W ETL forsted slim batten	32W	3850LM	120LM/W	Ra>80	AC100-277V	1-10V	PF>0.95	Y
BT06-62PTR-SFV1X-500	6ft-62W ETL forsted slim batten	62W	7500LM	120LM/W	Ra>80	AC100-277V	1-10V	PF>0.95	Y

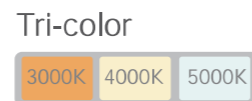

Features

- > Patent design for T8 fluorescent fitting
- > End or rear cable entry
- > Easy installation
- > 5 years warranty

Applications

- > Replacement for T8 /T5 fluorescent batten
- > Education light : Classroom
- > Office Light : Office, Conference room
- > Commercial Light : Supermarket , Shoppingmall

Options

- > Emitting color : Single or Tri-color
- > Dimming : on-off / 1-10V / DALI/PIR
- > Wiring method : Single or double sides
- > Installation : Surface mounting or Suspension

Dimensions

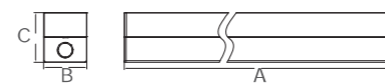

Product Name	A	B	C
60cm/2ft	642	55	63.5
120cm/4ft	1119	55	63.5
150cm/5ft	1473	55	63.5
180cm/6ft	1755	55	63.5

Unit:mm

LED Linear Light : Reflective Slim Batten

Reflective Slim Batten : Low Glare /UGR<19 100LM/W GS /ETL/DLC Approval



EU Style



• Data Sheet

Order Code	Product Name	Rated Power	Lumen Output	Lumen Efficacy	Color Index	AC Input	UGR	Power Factor	Flicker Free
Single Color Series									
BT02-10SN1-SRN1B-001	60CM-10W GS reflective slim batten	10W	1000LM	100LM/W	Ra>80	AC200-240V	<19	PF>0.95	Y
BT04-17SN1-SRN1B-001	120CM-17W GS reflective slim batten	17W	1700LM	100LM/W	Ra>80	AC200-240V	<19	PF>0.95	Y
BT05-28SN1-SRN1B-001	150CM-28W GS reflective slim batten	28W	2800LM	100LM/W	Ra>80	AC200-240V	<19	PF>0.95	Y
BT06-32SN1-SRN1B-001	180CM-32W GS reflective slim batten	32W	3200LM	100LM/W	Ra>80	AC200-240V	<19	PF>0.95	Y
Tri-color Series									
BT02-10STR-SRN1B-001	60CM-10W GS reflective slim batten	10W	1000LM	100LM/W	Ra>80	AC200-240V	<19	PF>0.95	Y
BT04-17STR-SRN1B-001	120CM-17W GS reflective slim batten	17W	1700LM	100LM/W	Ra>80	AC200-240V	<19	PF>0.95	Y
BT05-28STR-SRN1B-001	150CM-28W GS reflective slim batten	28W	2800LM	100LM/W	Ra>80	AC200-240V	<19	PF>0.95	Y
BT06-32STR-SRN1B-001	180CM-32W GS reflective slim batten	32W	3200LM	100LM/W	Ra>80	AC200-240V	<19	PF>0.95	Y



North American Style : 1-10V Dimming as standard



• Data Sheet

Order Code	Product Name	Rated Power	Lumen Output	Lumen Efficacy	Color Index	AC Input	UGR	Power Factor	Flicker Free
Single Color Series									
BT02-10SN1-SRV1X-500	2ft-10W ETL reflective slim batten	10W	1000LM	100LM/W	Ra>80	AC100-277V	<19	PF>0.95	Y
BT04-17SN1-SRV1X-500	4ft-17W ETL reflective slim batten	17W	1700LM	100LM/W	Ra>80	AC100-277V	<19	PF>0.95	Y
BT05-28SN1-SRV1X-500	5ft-28W ETL reflective slim batten	28W	2800LM	100LM/W	Ra>80	AC100-277V	<19	PF>0.95	Y
BT06-32SN1-SRV1X-500	6ft-32W ETL reflective slim batten	32W	3200LM	100LM/W	Ra>80	AC100-277V	<19	PF>0.95	Y
Tri-color Series									
BT02-10STR-SRV1X-500	2ft-10W ETL reflective slim batten	10W	1000LM	100LM/W	Ra>80	AC100-277V	<19	PF>0.95	Y
BT04-17STR-SRV1X-500	4ft-17W ETL reflective slim batten	17W	1700LM	100LM/W	Ra>80	AC100-277V	<19	PF>0.95	Y
BT05-28STR-SRV1X-500	5ft-28W ETL reflective slim batten	28W	2800LM	100LM/W	Ra>80	AC100-277V	<19	PF>0.95	Y
BT06-32STR-SRV1X-500	6ft-32W ETL reflective slim batten	32W	3200LM	100LM/W	Ra>80	AC100-277V	<19	PF>0.95	Y



UGR <19 | 1~10V dimming | 5 YR

Tri-color
3000K | 4000K | 5000K

Features

- > Low glare /UGR<19
- > End or rear cable entry
- > Easy installation
- > 5 years warranty

Applications

- > Replacement for T8 /T5 fluorescent batten
- > Education light : Classroom
- > Office Light : Office, Conference room
- > Commercial Light : Supermarket , Shoppingmall

Options

- > Emitting color : Single or Tri-color
- > Dimming : on-off / 1-10V / DALI
- > Wiring method : Single or double sides
- > Installation : Surface mounting or Suspension

Dimensions



Product Name	A	B	C
60cm/2ft	642	55	63.5
120cm/4ft	1119	55	63.5
150cm/5ft	1473	55	63.5
180cm/6ft	1755	55	63.5

Unit:mm

LED Linear Light : Gentle Upton Batten

Gentle Upton Batten : Low Glare /UGR<19 110LM/W GS /ETL/DLC Approval

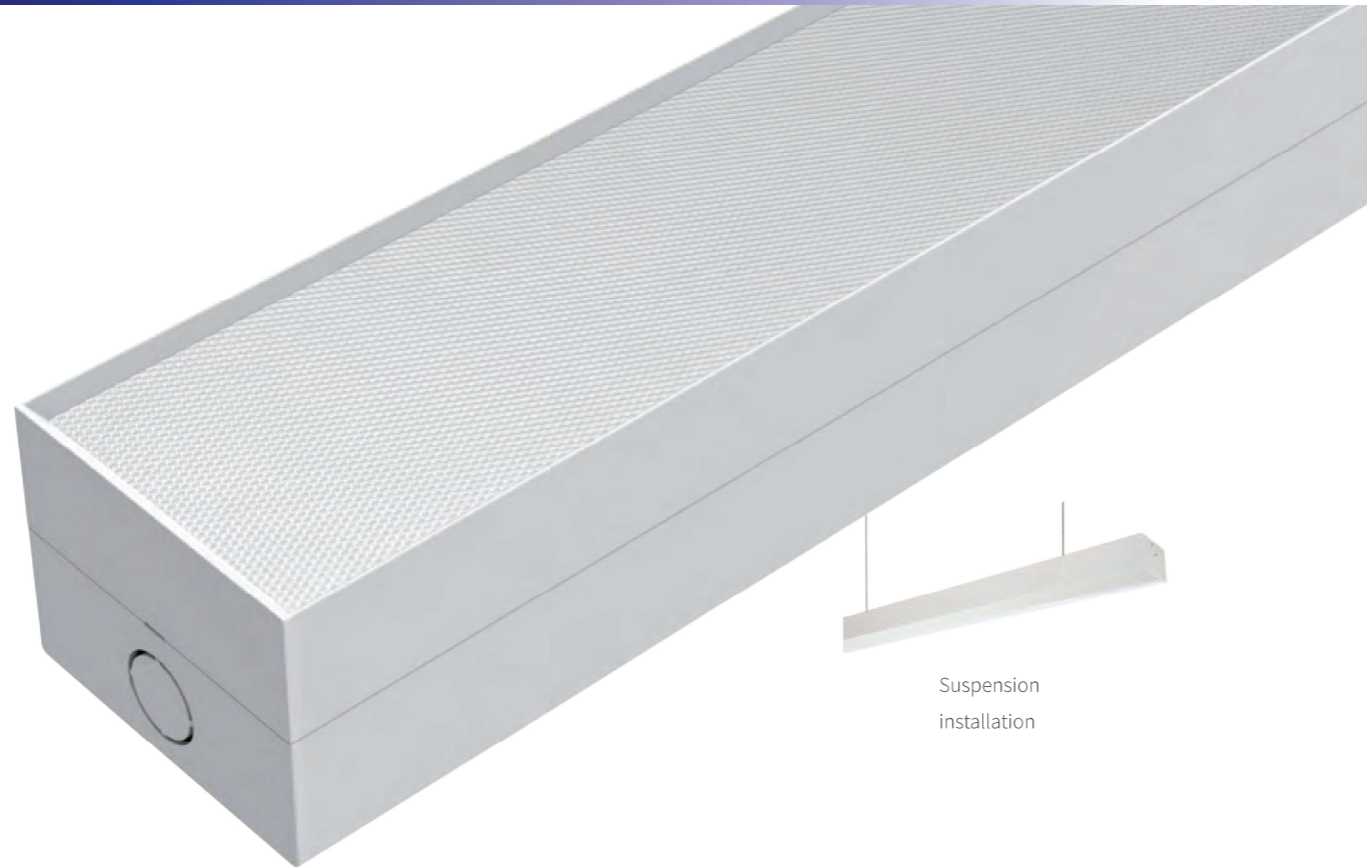

Suspension installation

UGR <19 1~10V dimming 5 YR

Tri-color
3000K 4000K 5000K

Features

- > Low glare / UGR<19
- > End or rear cable entry
- > Easy open between up-down case
- > Easy installation
- > 5 years warranty

Applications

- > Replacement for normal battens
- > Education light : Classroom
- > Office Light : Office, Conference room
- > Commercial Light : Supermarket , Shopping mall

Options

- > Emitting color : Tri-color as standard
- > Dimming : on-off / 1-10V / DALI
- > Wiring method : Single or double sides
- > Installation : Surface mounting or Suspension

Dimensions

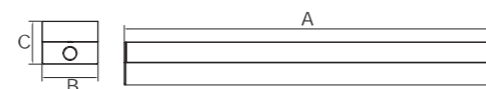

Product Name	A	B	C
60cm/2ft	600	80	63.5
120cm/4ft	1200	80	63.5
150cm/5ft	1500	80	63.5
180cm/6ft	1800	80	63.5

Unit:mm

EU Style



• Data Sheet

Order Code	Product Name	Rated Power	Lumen Output	Lumen Efficacy	Color Index	AC Input	UGR	Power Factor	Flicker Free
Tri-Color									
BT02-10KTR-UGN1B-001	60CM-10W GS gentle upton batten	10W	1100LM	110LM/W	Ra>80	AC200-240V	<19	PF>0.95	Y
BT04-17KTR-UGN1B-001	120CM-17W GS gentle upton batten	17W	1850LM	110LM/W	Ra>80	AC200-240V	<19	PF>0.95	Y
BT04-32KTR-UGN1B-001	120CM-32W GS gentle upton batten	32W	3500LM	110LM/W	Ra>80	AC200-240V	<19	PF>0.95	Y
BT05-22KTR-UGN1B-001	150CM-22W GS gentle upton batten	22W	2400LM	110LM/W	Ra>80	AC200-240V	<19	PF>0.95	Y
BT05-40KTR-UGN1B-001	150CM-40W GS gentle upton batten	40W	4400LM	110LM/W	Ra>80	AC200-240V	<19	PF>0.95	Y
BT06-27KTR-UGN1B-001	180CM-27W GS gentle upton batten	27W	2950LM	110LM/W	Ra>80	AC200-240V	<19	PF>0.95	Y
BT06-50KTR-UGN1B-001	180CM-50W GS gentle upton batten	50W	5500LM	110LM/W	Ra>80	AC200-240V	<19	PF>0.95	Y



North American Style : 1-10V Dimming as standard



• Data Sheet

Order Code	Product Name	Rated Power	Lumen Output	Lumen Efficacy	Color Index	AC Input	UGR	Power Factor	Flicker Free
Tri-Color									
BT02-10KTR-UGV1X-500	2ft-10W ETL gentle upton batten	10W	1100LM	110LM/W	Ra>80	AC100-277V	<19	PF>0.95	Y
BT04-17KTR-UGV1X-500	4ft-17W ETL gentle upton batten	17W	1850LM	110LM/W	Ra>80	AC100-277V	<19	PF>0.95	Y
BT04-32KTR-UGV1X-500	4ft-32W ETL gentle upton batten	32W	3500LM	110LM/W	Ra>80	AC100-277V	<19	PF>0.95	Y
BT05-22KTR-UGV1X-500	5ft-22W ETL gentle upton batten	22W	2400LM	110LM/W	Ra>80	AC100-277V	<19	PF>0.95	Y
BT05-40KTR-UGV1X-500	5ft-40W ETL gentle upton batten	40W	4400LM	110LM/W	Ra>80	AC100-277V	<19	PF>0.95	Y
BT06-27KTR-UGV1X-500	6ft-27W ETL gentle upton batten	27W	2950LM	110LM/W	Ra>80	AC100-277V	<19	PF>0.95	Y
BT06-50KTR-UGV1X-500	6ft-50W ETL gentle upton batten	50W	5500LM	110LM/W	Ra>80	AC100-277V	<19	PF>0.95	Y



LED Linear Light : Frosted Upton Batten

Frosted Upton Batten 120LM/W GS /ETL /DLC approval

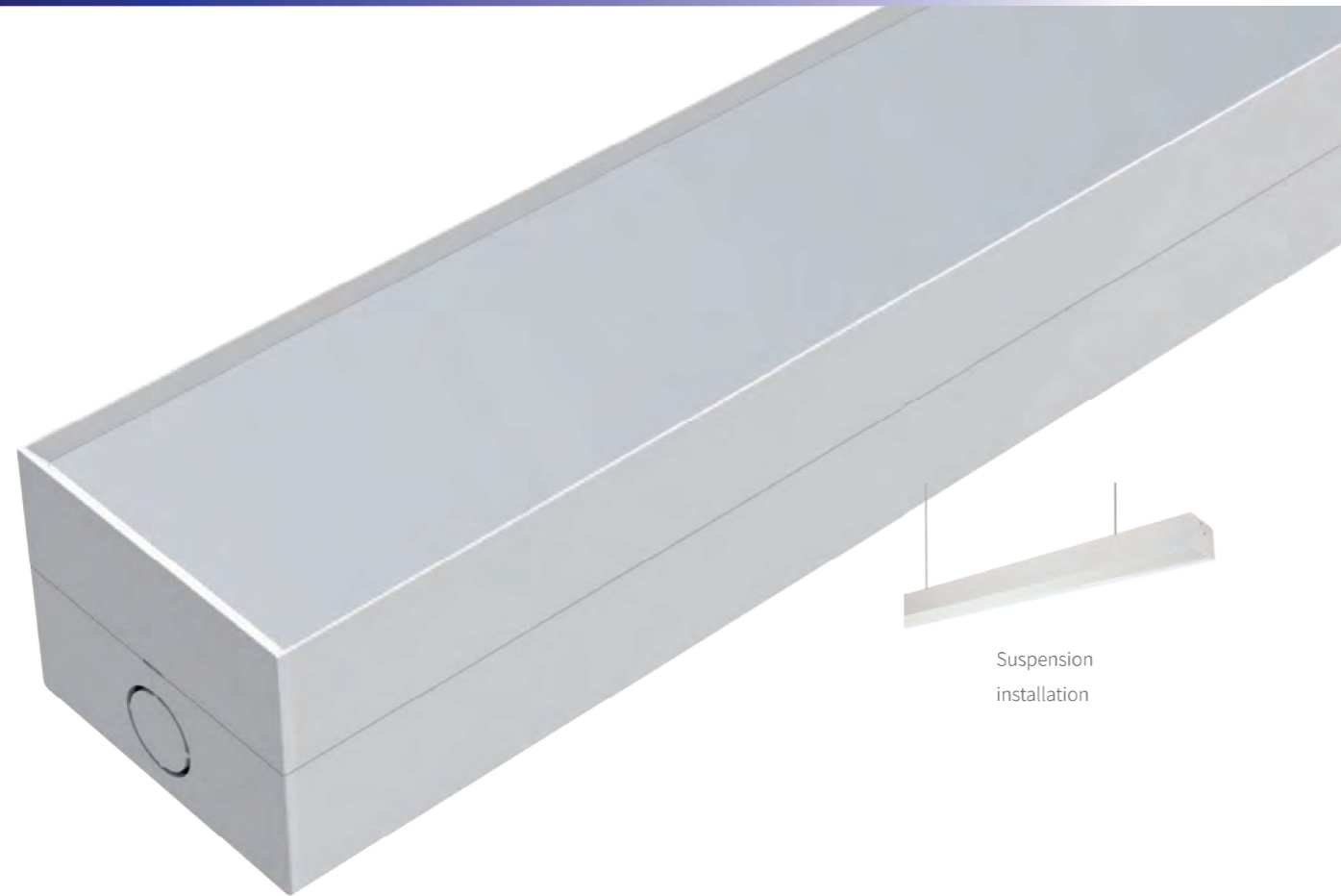

Suspension installation

DALI
1~10V
5 YR

Tri-color

3000K
4000K
5000K

Features

- > Easy open between up-down case
- > End or rear cable entry
- > Easy installation
- > 5 years warranty

Applications

- > Replacement for normal battens
- > Education light : Classroom
- > Office Light : Office, Conference room
- > Commercial Light : Supermarket , Shopping mall

Options

- > Emitting color : Single or Tri-color
- > Dimming : on-off / 1-10V / DALI/PIR
- > Wiring method : Single or double sides
- > Installation : Surface mounting or Suspension

Dimensions

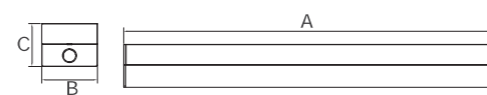

Product Name	A	B	C
60cm/2ft	600	80	63.5
120cm/4ft	1200	80	63.5
150cm/5ft	1500	80	63.5
180cm/6ft	1800	80	63.5

Unit:mm

EU Style



• Data Sheet

Order Code	Product Name	Rated Power	Lumen Output	Lumen Efficacy	Color Index	AC Input	UGR	Power Factor	Flicker Free
Tri-Color									
BT02-10PTR-UFN1B-001	60CM-10W GS frosted upton batten	10W	1250LM	125LM/W	Ra>80	AC200-240V	>19	PF>0.95	Y
BT04-17PTR-UFN1B-001	120CM-17W GS frosted upton batten	17W	2150LM	125LM/W	Ra>80	AC200-240V	>19	PF>0.95	Y
BT04-32PTR-UFN1B-001	120CM-32W GS frosted upton batten	32W	4000LM	125LM/W	Ra>80	AC200-240V	>19	PF>0.95	Y
BT05-22PTR-UFN1B-001	150CM-22W GS frosted upton batten	22W	2750LM	125LM/W	Ra>80	AC200-240V	>19	PF>0.95	Y
BT05-40PTR-UFN1B-001	150CM-40W GS frosted upton batten	40W	5000LM	125LM/W	Ra>80	AC200-240V	>19	PF>0.95	Y
BT06-27PTR-UFN1B-001	180CM-27W GS frosted upton batten	27W	3350LM	125LM/W	Ra>80	AC200-240V	>19	PF>0.95	Y
BT06-50PTR-UFN1B-001	180CM-50W GS frosted upton batten	50W	6250LM	125LM/W	Ra>80	AC200-240V	>19	PF>0.95	Y



North American Style : 1-10V Dimming as standard



• Data Sheet

Order Code	Product Name	Rated Power	Lumen Output	Lumen Efficacy	Color Index	AC Input	UGR	Power Factor	Flicker Free
Tri-Color									
BT02-10PTR-UFV1X-500	2ft-10W ETL frosted upton batten	10W	1250LM	125LM/W	Ra>80	AC100-277V	>19	PF>0.95	Y
BT04-17PTR-UFV1X-500	4ft-17W ETL frosted upton batten	17W	2150LM	125LM/W	Ra>80	AC100-277V	>19	PF>0.95	Y
BT04-32PTR-UFV1X-500	4ft-32W ETL frosted upton batten	32W	4000LM	125LM/W	Ra>80	AC100-277V	>19	PF>0.95	Y
BT05-22PTR-UFV1X-500	5ft-22W ETL frosted upton batten	22W	2750LM	125LM/W	Ra>80	AC100-277V	>19	PF>0.95	Y
BT05-40PTR-UFV1X-500	5ft-40W ETL frosted upton batten	40W	5000LM	125LM/W	Ra>80	AC100-277V	>19	PF>0.95	Y
BT06-27PTR-UFV1X-500	6ft-27W ETL frosted upton batten	27W	3350LM	125LM/W	Ra>80	AC100-277V	>19	PF>0.95	Y
BT06-50PTR-UFV1X-500	6ft-50W ETL frosted upton batten	50W	6250LM	125LM/W	Ra>80	AC100-277V	>19	PF>0.95	Y



LED Linear Light : Reflective Upton Batten

Reflective Upton Batten : Low Glare /UGR<19 110LM/W GS /ETL/DLC Approval

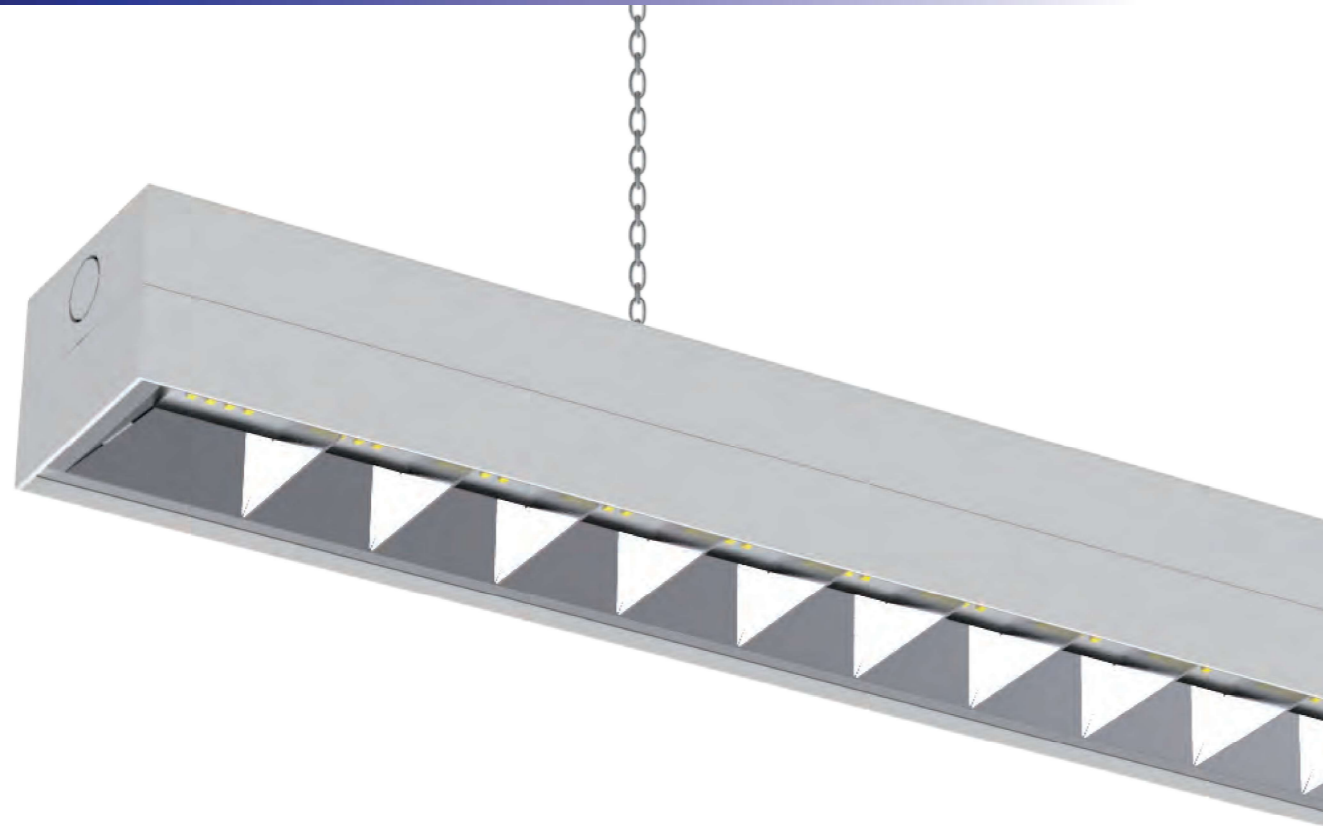

EU Style



• Data Sheet

Order Code	Product Name	Rated Power	Lumen Output	Lumen Efficacy	Color Index	AC Input	UGR	Power Factor	Flicker Free
Tri-Color									
BT02-10KTR-URN1B-001	60CM-10W GS reflective upton batten	10W	1100LM	110LM/W	Ra>80	AC200-240V	<19	PF>0.95	Y
BT04-17KTR-URN1B-001	120CM-17W GS reflective upton batten	17W	1850LM	110LM/W	Ra>80	AC200-240V	<19	PF>0.95	Y
BT04-32KTR-URN1B-001	120CM-32W GS reflective upton batten	32W	3500LM	110LM/W	Ra>80	AC200-240V	<19	PF>0.95	Y
BT05-22KTR-URN1B-001	150CM-22W GS reflective upton batten	22W	2400LM	110LM/W	Ra>80	AC200-240V	<19	PF>0.95	Y
BT05-40KTR-URN1B-001	150CM-40W GS reflective upton batten	40W	4400LM	110LM/W	Ra>80	AC200-240V	<19	PF>0.95	Y
BT06-27KTR-URN1B-001	180CM-27W GS reflective upton batten	27W	2950LM	110LM/W	Ra>80	AC200-240V	<19	PF>0.95	Y
BT06-50STR-URN1B-001	180CM-50W GS reflective upton batten	50W	5500LM	110LM/W	Ra>80	AC200-240V	<19	PF>0.95	Y



North American Style : 1-10V Dimming as standard



• Data Sheet

Order Code	Product Name	Rated Power	Lumen Output	Lumen Efficacy	Color Index	AC Input	UGR	Power Factor	Flicker Free
Tri-Color									
BT02-10KTR-URV1X-500	2ft-10W ETL reflective upton batten	10W	1100LM	110LM/W	Ra>80	AC100-277V	<19	PF>0.95	Y
BT04-17KTR-URV1X-500	4ft-17W ETL reflective upton batten	17W	1850LM	110LM/W	Ra>80	AC100-277V	<19	PF>0.95	Y
BT04-32KTR-URV1X-500	4ft-32W ETL reflective upton batten	32W	3500LM	110LM/W	Ra>80	AC100-277V	<19	PF>0.95	Y
BT05-22KTR-URV1X-500	5ft-22W ETL reflective upton batten	22W	2400LM	110LM/W	Ra>80	AC100-277V	<19	PF>0.95	Y
BT05-40KTR-URV1X-500	5ft-40W ETL reflective upton batten	40W	4400LM	110LM/W	Ra>80	AC100-277V	<19	PF>0.95	Y
BT06-27KTR-URV1X-500	6ft-27W ETL reflective upton batten	27W	2950LM	110LM/W	Ra>80	AC100-277V	<19	PF>0.95	Y
BT06-50KTR-URV1X-500	6ft-50W ETL reflective upton batten	50W	5500LM	110LM/W	Ra>80	AC100-277V	<19	PF>0.95	Y



UGR <19

1~10V dimming

5 YR

Tri-color

3000K 4000K 5000K

Features

- > Low glare / UGR<19
- > End or rear cable entry
- > Easy open between up-down case
- > Easy installation
- > 5 years warranty

Applications

- > Replacement for normal battens
- > Education light : Classroom
- > Office Light : Office, Conference room
- > Commercial Light : Supermarket , Shopping mall

Options

- > Emitting color : Tri-color as standard
- > Dimming : on-off / 1-10V / DALI
- > Wiring method : Single or double sides
- > Installation : Surface mounting or Suspension

Dimensions

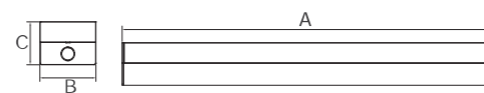

Product Name	A	B	C
60cm/2ft	600	80	63.5
120cm/4ft	1200	80	63.5
150cm/5ft	1500	80	63.5
180cm/6ft	1800	80	63.5

Unit:mm

LED Linear Light : Blackboard Batten

Blackboard Batten : 110LM/W GS /ETL/DLC Approval



1~10V dimming

5 YR

Tri-color

3000K 4000K 5000K

Features

- > Patent design for education lighting
- > End or rear cable entry
- > Easy open between up-down case
- > Easy installation
- > 5 years warranty

Applications

- > Replacement for blackboard light
- > Education light : Classroom
- > Office Light : Office, Conference room
- > Commercial Light : Supermarket , Shopping mall

Options

- > Emitting color : Tri-color as standard
- > Dimming : on-off / 1-10V / DALI
- > Wiring method : Single or double sides
- > Installation : Surface mounting or Suspension

Dimensions

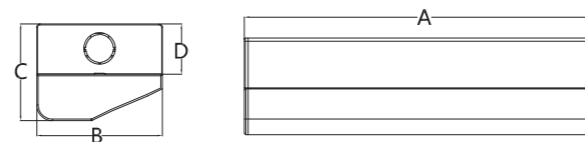

Product Name	A	B	C	D
120cm/4ft	1205	80	63.5	32
150cm/5ft	1505	80	63.5	32
180cm/6ft	1805	80	63.5	32

Unit:mm

EU Style

• Data Sheet

Order Code	Product Name	Rated Power	Lumen Output	Lumen Efficacy	Color Index	AC Input	Power Factor	Flicker Free
Tri-Color								
BT04-17PTR-BFN1B-001	120CM-17W GS blackboard batten	17W	2050LM	120LM/W	Ra>80	AC200-240V	PF>0.95	Y
BT04-32PTR-BFN1B-001	120CM-32W GS blackboard batten	32W	3850LM	120LM/W	Ra>80	AC200-240V	PF>0.95	Y
BT05-22PTR-BFN1B-001	150CM-22W GS blackboard batten	22W	2650LM	120LM/W	Ra>80	AC200-240V	PF>0.95	Y
BT05-40PTR-BFN1B-001	150CM-40W GS blackboard batten	40W	4800LM	120LM/W	Ra>80	AC200-240V	PF>0.95	Y



North American Style : 1-10V Dimming as standard

• Data Sheet

Order Code	Product Name	Rated Power	Lumen Output	Lumen Efficacy	Color Index	AC Input	Power Factor	Flicker Free
Tri-Color								
BT04-17PTR-BFV1X-500	4ft-17W ETL blackboard batten	17W	2050LM	120LM/W	Ra>80	AC100-277V	PF>0.95	Y
BT04-32PTR-BFV1X-500	4ft-32W ETL blackboard batten	32W	3850LM	120LM/W	Ra>80	AC100-277V	PF>0.95	Y
BT05-22PTR-BFV1X-500	5ft-22W ETL blackboard batten	22W	2650LM	120LM/W	Ra>80	AC100-277V	PF>0.95	Y
BT05-40PTR-BFV1X-500	5ft-40W ETL blackboard batten	40W	4800LM	120LM/W	Ra>80	AC100-277V	PF>0.95	Y



LED Linear Light : Gentle Kingston Batten

Gentle Kingston Batten : Low Glare /UGR<19 110LM/W GS /ETL/DLC Approval



UGR
<19

1~10V
dimming

5 YR

Tri-color

3000K

4000K

5000K

Features

- > Low glare / UGR<19
- > End or rear cable entry
- > Easy open between up-down case
- > Easy installation
- > 5 years warranty

Applications

- > Replacement for normal battens
- > Education light : Classroom
- > Office Light : Office, Conference room
- > Commercial Light : Supermarket , Shopping mall

Options

- > Emitting color : Tri-color as standard
- > Dimming : on-off / 1-10V / DALI
- > Wiring method : Single or double sides
- > Installation : Surface mounting or Suspension

Dimensions

Product Name	A	B	C
60cm/2ft	600	120	63.5
120cm/4ft	1200	120	63.5
150cm/5ft	1500	120	63.5
180cm/6ft	1800	120	63.5

Unit:mm

EU Style



• Data Sheet

Order Code	Product Name	Rated Power	Lumen Output	Lumen Efficacy	Color Index	AC Input	UGR	Power Factor	Flicker Free
Tri-Color									
BT02-10KTR-KGN1B-001	60CM-10W GS gentle kingston batten	10W	1100LM	110LM/W	Ra>80	AC200-240V	<19	PF>0.95	Y
BT04-17KTR-KGN1B-001	120CM-17W GS gentle kingston batten	17W	1850LM	110LM/W	Ra>80	AC200-240V	<19	PF>0.95	Y
BT04-32KTR-KGN1B-001	120CM-32W GS gentle kingston batten	32W	3500LM	110LM/W	Ra>80	AC200-240V	<19	PF>0.95	Y
BT05-22KTR-KGN1B-001	150CM-22W GS gentle kingston batten	22W	2400LM	110LM/W	Ra>80	AC200-240V	<19	PF>0.95	Y
BT05-40KTR-KGN1B-001	150CM-40W GS gentle kingston batten	40W	4400LM	110LM/W	Ra>80	AC200-240V	<19	PF>0.95	Y
BT06-27KTR-KGN1B-001	180CM-27W GS gentle kingston batten	27W	2950LM	110LM/W	Ra>80	AC200-240V	<19	PF>0.95	Y
BT06-50KTR-KGN1B-001	180CM-50W GS gentle kingston batten	50W	5500LM	110LM/W	Ra>80	AC200-240V	<19	PF>0.95	Y



North American Style : 1-10V Dimming as standard



• Data Sheet

Order Code	Product Name	Rated Power	Lumen Output	Lumen Efficacy	Color Index	AC Input	UGR	Power Factor	Flicker Free
Tri-Color									
BT02-10KTR-KGV1X-500	2ft-10W ETL gentle kingston batten	10W	1100LM	110LM/W	Ra>80	AC100-277V	<19	PF>0.95	Y
BT04-17KTR-KGV1X-500	4ft-17W ETL gentle kingston batten	17W	1850LM	110LM/W	Ra>80	AC100-277V	<19	PF>0.95	Y
BT04-32KTR-KGV1X-500	4ft-32W ETL gentle kingston batten	32W	3500LM	110LM/W	Ra>80	AC100-277V	<19	PF>0.95	Y
BT05-22KTR-KGV1X-500	5ft-22W ETL gentle kingston batten	22W	2400LM	110LM/W	Ra>80	AC100-277V	<19	PF>0.95	Y
BT05-40KTR-KGV1X-500	5ft-40W ETL gentle kingston batten	40W	4400LM	110LM/W	Ra>80	AC100-277V	<19	PF>0.95	Y
BT06-27KTR-KGV1X-500	6ft-27W ETL gentle kingston batten	27W	2950LM	110LM/W	Ra>80	AC100-277V	<19	PF>0.95	Y
BT06-50KTR-KGV1X-500	6ft-50W ETL gentle kingston batten	50W	5500LM	110LM/W	Ra>80	AC100-277V	<19	PF>0.95	Y



LED Linear Light : Frosted Kingston Batten

Frosted Kingston Batten 120LM/W GS/ETL/DLC approval



EU Style



• Data Sheet

Order Code	Product Name	Rated Power	Lumen Output	Lumen Efficacy	Color Index	AC Input	UGR	Power Factor	Flicker Free
Tri-Color									
BT02-10PTR-KFN1B-001	60CM-10W GS frosted kingston batten	10W	1250LM	125LM/W	Ra>80	AC200-240V	>19	PF>0.95	Y
BT04-17PTR-KFN1B-001	120CM-17W GS frosted kingston batten	17W	2150LM	125LM/W	Ra>80	AC200-240V	>19	PF>0.95	Y
BT04-32PTR-KFN1B-001	120CM-32W GS frosted kingston batten	32W	4000LM	125LM/W	Ra>80	AC200-240V	>19	PF>0.95	Y
BT05-22PTR-KFN1B-001	150CM-22W GS frosted kingston batten	22W	2750LM	125LM/W	Ra>80	AC200-240V	>19	PF>0.95	Y
BT05-40PTR-KFN1B-001	150CM-40W GS frosted kingston batten	40W	5000LM	125LM/W	Ra>80	AC200-240V	>19	PF>0.95	Y
BT06-27PTR-KFN1B-001	180CM-27W GS frosted kingston batten	27W	3350LM	125LM/W	Ra>80	AC200-240V	>19	PF>0.95	Y
BT06-50PTR-KFN1B-001	180CM-50W GS frosted kingston batten	50W	6250LM	125LM/W	Ra>80	AC200-240V	>19	PF>0.95	Y



North American Style : 1-10V Dimming as standard



• Data Sheet

Order Code	Product Name	Rated Power	Lumen Output	Lumen Efficacy	Color Index	AC Input	UGR	Power Factor	Flicker Free
Tri-Color									
BT02-10PTR-KFV1X-500	2ft-10W ETL frosted kingston batten	10W	1250LM	125LM/W	Ra>80	AC100-277V	>19	PF>0.95	Y
BT04-17PTR-KFV1X-500	4ft-17W ETL frosted kingston batten	17W	2150LM	125LM/W	Ra>80	AC100-277V	>19	PF>0.95	Y
BT04-32PTR-KFV1X-500	4ft-32W ETL frosted kingston batten	32W	4000LM	125LM/W	Ra>80	AC100-277V	>19	PF>0.95	Y
BT05-22PTR-KFV1X-500	5ft-22W ETL frosted kingston batten	22W	2750LM	125LM/W	Ra>80	AC100-277V	>19	PF>0.95	Y
BT05-40PTR-KFV1X-500	5ft-40W ETL frosted kingston batten	40W	5000LM	125LM/W	Ra>80	AC100-277V	>19	PF>0.95	Y
BT06-27PTR-KFV1X-500	6ft-27W ETL frosted kingston batten	27W	3350LM	125LM/W	Ra>80	AC100-277V	>19	PF>0.95	Y
BT06-50PTR-KFV1X-500	6ft-50W ETL frosted kingston batten	50W	6250LM	125LM/W	Ra>80	AC100-277V	>19	PF>0.95	Y



Tri-color



Features

- > Easy open between up-down case
- > End or rear cable entry
- > Easy installation
- > 5 years warranty

Options

- > Emitting color : Single or Tri-color
- > Dimming : On-off / 1-10V / DALI/PIR
- > Wiring method : Single or double sides
- > Installation : Surface mounting or Suspension

Applications

- > Replacement for normal battens
- > Education light : Classroom
- > Office Light : Office, Conference room
- > Commercial Light : Supermarket , Shopping mall

Dimensions

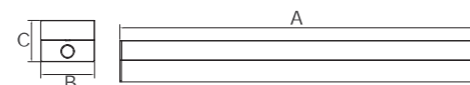

Product Name	A	B	C
60cm/2ft	600	120	63.5
120cm/4ft	1200	120	63.5
150cm/5ft	1500	120	63.5
180cm/6ft	1800	120	63.5

Unit:mm

LED Linear Light : Reflective Kingston Batten

Reflective Kingston Batten : Low Glare /UGR<19 110LM/W GS /ETL/DLC Approval



EU Style



• Data Sheet

Order Code	Product Name	Rated Power	Lumen Output	Lumen Efficacy	Color Index	AC Input	UGR	Power Factor	Flicker Free
Tri-Color									
BT02-10KTR-KRN1B-001	60CM-10W GS reflective kingston batten	10W	1100LM	110LM/W	Ra>80	AC200-240V	<19	PF>0.95	Y
BT04-17KTR-KRN1B-001	120CM-17W GS reflective kingston batten	17W	1850LM	110LM/W	Ra>80	AC200-240V	<19	PF>0.95	Y
BT04-32KTR-KRN1B-001	120CM-32W GS reflective kingston batten	32W	3500LM	110LM/W	Ra>80	AC200-240V	<19	PF>0.95	Y
BT05-22KTR-KRN1B-001	150CM-22W GS reflective kingston batten	22W	2400LM	110LM/W	Ra>80	AC200-240V	<19	PF>0.95	Y
BT05-40KTR-KRN1B-001	150CM-40W GS reflective kingston batten	40W	4400LM	110LM/W	Ra>80	AC200-240V	<19	PF>0.95	Y
BT06-27KTR-KRN1B-001	180CM-27W GS reflective kingston batten	27W	2950LM	110LM/W	Ra>80	AC200-240V	<19	PF>0.95	Y
BT06-50STR-KRN1B-001	180CM-50W GS reflective kingston batten	50W	5500LM	110LM/W	Ra>80	AC200-240V	<19	PF>0.95	Y



North American Style : 1-10V Dimming as standard



• Data Sheet

Order Code	Product Name	Rated Power	Lumen Output	Lumen Efficacy	Color Index	AC Input	UGR	Power Factor	Flicker Free
Tri-Color									
BT02-10KTR-KRV1X-500	2ft-10W ETL reflective kingston batten	10W	1100LM	110LM/W	Ra>80	AC100-277V	<19	PF>0.95	Y
BT04-17KTR-KRV1X-500	4ft-17W ETL reflective kingston batten	17W	1850LM	110LM/W	Ra>80	AC100-277V	<19	PF>0.95	Y
BT04-32KTR-KRV1X-500	4ft-32W ETL reflective kingston batten	32W	3500LM	110LM/W	Ra>80	AC100-277V	<19	PF>0.95	Y
BT05-22KTR-KRV1X-500	5ft-22W ETL reflective kingston batten	22W	2400LM	110LM/W	Ra>80	AC100-277V	<19	PF>0.95	Y
BT05-40KTR-KRV1X-500	5ft-40W ETL reflective kingston batten	40W	4400LM	110LM/W	Ra>80	AC100-277V	<19	PF>0.95	Y
BT06-27KTR-KRV1X-500	6ft-27W ETL reflective kingston batten	27W	2950LM	110LM/W	Ra>80	AC100-277V	<19	PF>0.95	Y
BT06-50KTR-KRV1X-500	6ft-50W ETL reflective kingston batten	50W	5500LM	110LM/W	Ra>80	AC100-277V	<19	PF>0.95	Y



UGR <19

1~10V dimming

5 YR

Tri-color

3000K

4000K

5000K

Features

- > Low glare / UGR<19
- > End or rear cable entry
- > Easy open between up-down case
- > Easy installation
- > 5 years warranty

Application

- > Replacement for normal battens
- > Education light : Classroom
- > Office Light : Office, Conference room
- > Commercial Light : Supermarket , Shopping mall

Options

- > Emitting color : Tri-color as standard
- > Dimming : on-off / 1-10V / DALI
- > Wiring method : Single or double sides
- > Installation : Surface mounting or Suspension

Dimension

Product Name	A	B	C
60cm/2ft	600	120	63.5
120cm/4ft	1200	120	63.5
150cm/5ft	1500	120	63.5
180cm/6ft	1800	120	63.5

Unit:mm

General Batten Light

General Batten : 115LM/W GS/ETL/DLC aproval



EU Style

• Data Sheet

Order Code	Product Name	Rated Power	Lumen Output	Lumen Efficacy	Color Index	UGR	AC Input	Power Factor	Flicker Free
BT02-10KN1-GMN1B-001	60CM-10W GS general batten	10W	1150LM	115LM/W	Ra>80	>19	AC200-240V	PF>0.95	Y
BT04-17KN1-GMN1B-001	120CM-17W GS general batten	17W	1950LM	115LM/W	Ra>80	>19	AC200-240V	PF>0.95	Y
BT04-32KN1-GMN1B-001	120CM-32W GS general batten	32W	3700LM	115LM/W	Ra>80	>19	AC200-240V	PF>0.95	Y
BT05-25KN1-GMN1B-001	150CM-25W GS general batten	25W	2850LM	115LM/W	Ra>80	>19	AC200-240V	PF>0.95	Y
BT05-50KN1-GMN1B-001	150CM-50W GS general batten	50W	5750LM	115LM/W	Ra>80	>19	AC200-240V	PF>0.95	Y
BT06-30KN1-GMN1B-001	150CM-30W GS general batten	30W	3450LM	115LM/W	Ra>80	>19	AC200-240V	PF>0.95	Y
BT06-60KN1-GMN1B-001	180CM-60W GS general batten	60W	6900LM	115LM/W	Ra>80	>19	AC200-240V	PF>0.95	Y



1~10V dimming

5 YR

Features

- > Easy opening design for cover
- > End or rear cable entry
- > Easy installation
- > 5 years warranty

Applications

- > Replacement for normal battens
- > Education light : Classroom
- > Office Light : Office, Conference room
- > Commercial Light : Supermarket , Shopping mall

Options

- > Emitting color : Single or Tri-color
- > Dimming : On-off / 1-10V / DALI
- > Installation : Surface mounting or Suspension

Dimensions

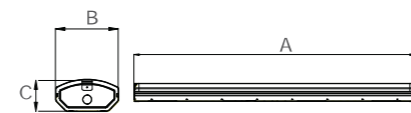

Product Name	A	B	C
0.6M/2ft	600	152	77
1.2M/4ft	1200	152	77
1.5M/5ft	1500	152	77
1.8M/6ft	1800	152	77

Unit:mm

North American Style :1-10V Dimming as standard

• Data Sheet

Order Code	Product Name	Rated Power	Lumen Output	Lumen Efficacy	Color Index	UGR	AC Input	Power Factor	Flicker Free
BT02-10KN1-GMV1X-500	60CM-10W ETL general batten	10W	1150LM	115LM/W	Ra>80	>19	AC100-277V	PF>0.95	Y
BT04-17KN1-GMV1X-500	120CM-17W ETL general batten	17W	1950LM	115LM/W	Ra>80	>19	AC100-277V	PF>0.95	Y
BT04-32KN1-GMV1X-500	120CM-32W ETL general batten	32W	3700LM	115LM/W	Ra>80	>19	AC100-277V	PF>0.95	Y
BT05-25KN1-GMV1X-500	150CM-25W ETL general batten	25W	2850LM	115LM/W	Ra>80	>19	AC100-277V	PF>0.95	Y
BT05-50KN1-GMV1X-500	150CM-50W ETL general batten	50W	5750LM	115LM/W	Ra>80	>19	AC100-277V	PF>0.95	Y
BT06-30KN1-GMV1X-500	150CM-30W ETL general batten	30W	3450LM	115LM/W	Ra>80	>19	AC100-277V	PF>0.95	Y
BT06-60KN1-GMV1X-500	180CM-60W ETL general batten	60W	6900LM	115LM/W	Ra>80	>19	AC100-277V	PF>0.95	Y



ARCO Batten Light

ARCO Batten : Special College Fitting 115LM/W GS /ETL /DLC aproval



EU Style



• Data Sheet

Order Code	Product Name	Rated Power	Lumen Output	Lumen Efficacy	Color Index	UGR	AC Input	Power Factor	Flicker Free
BT04-17KN1-AFN1B-001	120CM-17W GS arco batten	17W	1950LM	115LM/W	Ra>80	>19	AC200-240V	PF>0.95	Y
BT04-32KN1-AFN1B-001	120CM-32W GS arco batten	32W	3700LM	115LM/W	Ra>80	>19	AC200-240V	PF>0.95	Y
BT05-25KN1-AFN1B-001	150CM-25W GS arco batten	25W	2850LM	115LM/W	Ra>80	>19	AC200-240V	PF>0.95	Y
BT05-50KN1-AFN1B-001	150CM-50W GS arco batten	50W	5750LM	115LM/W	Ra>80	>19	AC200-240V	PF>0.95	Y



1~10V dimming

5 YR

Features

- > Special case for college fitting
- > Easy opening design for cover
- > End or rear cable entry
- > Easy installation
- > 5 years warranty

Applications

- > Replacement for normal battens
- > Education light : Classroom
- > Office Light : Office, Conference room
- > Commercial Light : Supermarket , Shopping mall

Options

- > Emitting color : Single or Tri-color
- > Dimming : On-off / 1-10V / DALI
- > Installation : Surface mounting or Suspension

Dimensions

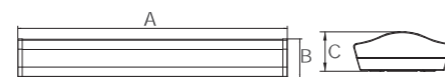

Product Name	A	B	C
1.2M/4ft	1200	215	77
1.5M/5ft	1500	215	77

Unit:mm

North American Style :1-10V Dimming as standard



• Data Sheet

Order Code	Product Name	Rated Power	Lumen Output	Lumen Efficacy	Color Index	UGR	AC Input	Power Factor	Flicker Free
BT04-17KN1-AFV1X-500	120CM-17W ETL arco batten	17W	1950LM	115LM/W	Ra>80	>19	AC100-277V	PF>0.95	Y
BT04-32KN1-AFV1X-500	120CM-32W ETL arco batten	32W	3700LM	115LM/W	Ra>80	>19	AC100-277V	PF>0.95	Y
BT05-25KN1-AFV1X-500	150CM-25W ETL arco batten	25W	2850LM	115LM/W	Ra>80	>19	AC100-277V	PF>0.95	Y
BT05-50KN1-AFV1X-500	150CM-50W ETL arco batten	50W	5750LM	115LM/W	Ra>80	>19	AC100-277V	PF>0.95	Y





LED Tri-proof Light

60%
energy saving

50,000
hours life

5 years
warranty

A version : Plastic Tri-proof Light (NCF)

Full Plastic Case , DALI /1-10V /MS Dimming



Standard NCF :100LM/W



• Data Sheet

Order Code	ProductName	Rated Power	Lumen Output	Lumen Efficacy	Color Index	AC Input	Power Factor	IP /IK Class
Single Color								
TR02-20SN1-AFN1B-001	60CM-20W Standard single color NCF	20W	2000LM	100LM/W	Ra>80	AC200-240V	PF>0.95	IP65 / IK08
TR04-35SN1-AFN1B-001	120CM-35W Standard single color NCF	35W	3500LM	100LM/W	Ra>80	AC200-240V	PF>0.95	IP65 / IK08
TR05-40SN1-AFN1B-001	150CM-40W Standard single color NCF	40W	4000LM	100LM/W	Ra>80	AC200-240V	PF>0.95	IP65 / IK08
TR05-55SN1-AFN1B-001	150CM-55W Standard single color NCF	55W	5500LM	100LM/W	Ra>80	AC200-240V	PF>0.95	IP65 / IK08
TR05-75SN1-AFN1B-001	150CM-75W Standard single color NCF	75W	7500LM	100LM/W	Ra>80	AC200-240V	PF>0.95	IP65 / IK08
Tri-color								
TR02-20STR-AFN1B-001	60CM-20W Standard tri-color NCF	20W	2000LM	100LM/W	Ra>80	AC200-240V	PF>0.95	IP65 / IK08
TR04-35STR-AFN1B-001	120CM-35W Standard tri-color NCF	35W	3500LM	100LM/W	Ra>80	AC200-240V	PF>0.95	IP65 / IK08
TR05-40STR-AFN1B-001	150CM-40W Standard tri-color NCF	40W	4000LM	100LM/W	Ra>80	AC200-240V	PF>0.95	IP65 / IK08
TR05-55STR-AFN1B-001	150CM-55W Standard tri-color NCF	55W	5500LM	100LM/W	Ra>80	AC200-240V	PF>0.95	IP65 / IK08
TR05-75STR-AFN1B-001	150CM-75W Standard tri-color NCF	75W	7500LM	100LM/W	Ra>80	AC200-240V	PF>0.95	IP65 / IK08

Premium NCF : 125LM/W



• Data Sheet

Order Code	ProductName	Rated Power	Lumen Output	Lumen Efficacy	Color Index	AC Input	Power Factor	IP /IK Class
Single Color								
TR02-20PN1-AFN1B-001	60CM-20W Premium single color NCF	20W	2500LM	125LM/W	Ra>80	AC200-240V	PF>0.95	IP65 / IK08
TR04-35PN1-AFN1B-001	120CM-35W Premium single color NCF	35W	4350LM	125LM/W	Ra>80	AC200-240V	PF>0.95	IP65 / IK08
TR05-40PN1-AFN1B-001	150CM-40W Premium single color NCF	40W	5000LM	125LM/W	Ra>80	AC200-240V	PF>0.95	IP65 / IK08
TR05-55PN1-AFN1B-001	150CM-55W Premium single color NCF	55W	6850LM	125LM/W	Ra>80	AC200-240V	PF>0.95	IP65 / IK08
TR05-75PN1-AFN1B-001	150CM-75W Premium single color NCF	75W	9350LM	125LM/W	Ra>80	AC200-240V	PF>0.95	IP65 / IK08
Tri-color								
TR02-20PTR-AFN1B-001	60CM-20W Premium tri-color NCF	20W	2500LM	125LM/W	Ra>80	AC200-240V	PF>0.95	IP65 / IK08
TR04-35PTR-AFN1B-001	120CM-35W Premium tri-color NCF	35W	4350LM	125LM/W	Ra>80	AC200-240V	PF>0.95	IP65 / IK08
TR05-40PTR-AFN1B-001	150CM-40W Premium tri-color NCF	40W	5000LM	125LM/W	Ra>80	AC200-240V	PF>0.95	IP65 / IK08
TR05-55PTR-AFN1B-001	150CM-55W Premium tri-color NCF	55W	6850LM	125LM/W	Ra>80	AC200-240V	PF>0.95	IP65 / IK08
TR05-75PTR-AFN1B-001	150CM-75W Premium tri-color NCF	75W	9350LM	125LM/W	Ra>80	AC200-240V	PF>0.95	IP65 / IK08

- DALI MS
- 1~10V dimming
- 5 YR

Tri-color

- 3000K
- 4000K
- 5000K

Features

- > IP65 waterproof /dust proof /explosion proof/ IK08
- > LED driver on tray for easy replacement
- > Multiple Link with double wiring
- > High technology SMD2835 as light source
- > 5 years warranty

Options

- > Emitting color : Single color or Tri-color
- > Dimming : 1-10V / DALI / MS
- > Wiring : Single or double sides
- > Lumen efficacy :
Standard : 100LM/W
Premium : 125LM/W

Applications

- > Replacement for fluorescent NCF
- > Warehouses , Factories, Car parks
- > Sport facilities, Outdoor & Indoor Locations

Dimensions

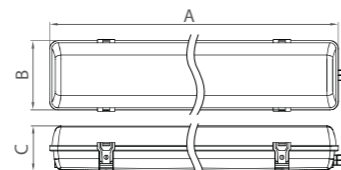

Product Name	A	B	C
60cm/2ft	650	130	85
120cm/4ft	1270	130	85
150cm/5ft	1560	130	85

Unit:mm



B version Tri-proof Light

EU Style



IP65

IK10

5 YR

Features

- > IP 65 / IK10 Approval
- > Multiple Link with double wirings
- > Patent aluminum case as heatsink
- > 5 years warranty

Applications

- > Replacement for fluorescent NCF
- > Warehouses , Factories, Car parks
- > Sport facilities, Outdoor & Indoor Locations

Options

- > Dimming : 1-10V / DALI
- > Wiring : Single or double sides
- > Lumen efficacy :
Standard : 100LM/W
Premium : 125LM/W
Deluxe:140LM/W

Dimensions

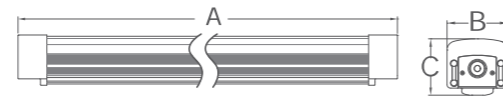

Product Name	A	B	C
2ft/60cm	625	85	78
4ft/120cm	1225	85	78
5ft/150cm	1525	85	78
8ft/240cm	2425	85	78

Unit:mm

Fujii Lights

TUV GS SAA CE RoHS

Standard Range : 100LM/W

Order Code	ProductName	Rated Power	Lumen Output	Lumen Efficacy	Color Index	AC Input	Power Factor	IP/IK Class
TR02-22SN1-BFN1B-001	60CM/22W Standard B Tri-proof	22W	2200LM	100LM/W	Ra>80	AC200-240V	PF>0.95	IP65 / IK10
TR04-40SN1-BFN1B-001	120CM/40W Standard B Tri-proof	40W	4000LM	100LM/W	Ra>80	AC200-240V	PF>0.95	IP65 / IK10
TR04-60SN1-BFN1B-001	120CM/60W Standard B Tri-proof	60W	6000LM	100LM/W	Ra>80	AC200-240V	PF>0.95	IP65 / IK10
TR05-60SN1-BFN1B-001	150CM/60W Standard B Tri-proof	60W	6000LM	100LM/W	Ra>80	AC200-240V	PF>0.95	IP65 / IK10
TR08-1ASN1-BFN1B-001	240CM/100W Standard B Tri-proof	100W	10000LM	100LM/W	Ra>80	AC200-240V	PF>0.95	IP65 / IK10

Premium Range : 125LM/W

Order Code	ProductName	Rated Power	Lumen Output	Lumen Efficacy	Color Index	AC Input	Power Factor	IP/IK Class
TR02-22PN1-BFN1B-001	60CM/22W Premium B Tri-proof	22W	2750LM	125LM/W	Ra>80	AC200-240V	PF>0.95	IP65 / IK10
TR04-40PN1-BFN1B-001	120CM/40W Premium B Tri-proof	40W	5000LM	125LM/W	Ra>80	AC200-240V	PF>0.95	IP65 / IK10
TR04-60PN1-BFN1B-001	120CM/60W Premium B Tri-proof	60W	7500LM	125LM/W	Ra>80	AC200-240V	PF>0.95	IP65 / IK10
TR05-60PN1-BFN1B-001	150CM/60W Premium B Tri-proof	60W	7500LM	125LM/W	Ra>80	AC200-240V	PF>0.95	IP65 / IK10
TR08-1APN1-BFN1B-001	240CM/100W Premium B Tri-proof	100W	12500LM	125LM/W	Ra>80	AC200-240V	PF>0.95	IP65 / IK10

Deluxe Range : 140LM/W

Order Code	ProductName	Rated Power	Lumen Output	Lumen Efficacy	Color Index	AC Input	Power Factor	IP/IK Class
TR02-22DN1-BFN1B-001	60CM/22W Deluxe B Tri-proof	22W	3050LM	140LM/W	Ra>80	AC200-240V	PF>0.95	IP65 / IK10
TR04-40DN1-BFN1B-001	120CM/40W Deluxe B Tri-proof	40W	5600LM	140LM/W	Ra>80	AC200-240V	PF>0.95	IP65 / IK10
TR04-60DN1-BFN1B-001	120CM/60W Deluxe B Tri-proof	60W	8400LM	140LM/W	Ra>80	AC200-240V	PF>0.95	IP65 / IK10
TR05-60DN1-BFN1B-001	150CM/60W Deluxe B Tri-proof	60W	8400LM	140LM/W	Ra>80	AC200-240V	PF>0.95	IP65 / IK10
TR08-1ADN1-BFN1B-001	240CM/100W Deluxe B Tri-proof	100W	14000LM	140LM/W	Ra>80	AC200-240V	PF>0.95	IP65 / IK10

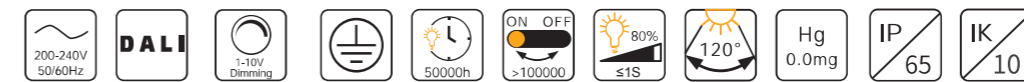

B version Tri-proof Light

North American Style



IP65
IK10

1~10V
dimming

5 YR

Features

- > IP 65 / IK10 Approval
- > Multiple Link with double wirings
- > Patent aluminum case as heatsink
- > 5 years warranty

Applications

- > Replacement for fluorescent NCF
- > Warehouses , Factories, Car parks
- > Sport facilities, Outdoor & Indoor Locations

Options

- > Dimming : 1-10V / DALI
- > Wiring : Single or double sides
- > Lumen efficacy :
Standard : 100LM/W
Premium : 125LM/W
Deluxe:140LM/W

Dimensions

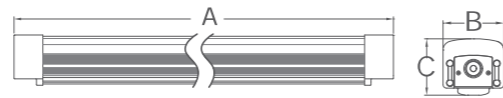

Product Name	A	B	C
2ft/60cm	625	85	78
4ft/120cm	1225	85	78
5ft/150cm	1525	85	78
8ft/240cm	2425	85	78

Unit:mm



Standard Range : 100LM/W

Order Code	ProductName	Rated Power	Lumen Output	Lumen Efficacy	Color Index	AC Input	Power Factor	IP/IK Class
TR02-22SN1-BFN1X-500	2ft/22W Standard B Tri-proof	22W	2200LM	100LM/W	Ra>80	AC100-277V	PF>0.95	IP65 / IK10
TR04-40SN1-BFN1X-500	4ft/40W Standard B Tri-proof	40W	4000LM	100LM/W	Ra>80	AC100-277V	PF>0.95	IP65 / IK10
TR04-60SN1-BFN1X-500	4ft/60W Standard B Tri-proof	60W	6000LM	100LM/W	Ra>80	AC100-277V	PF>0.95	IP65 / IK10
TR05-60SN1-BFN1X-500	5ft/60W Standard B Tri-proof	60W	6000LM	100LM/W	Ra>80	AC100-277V	PF>0.95	IP65 / IK10
TR08-1ASN1-BFN1X-500	8ft/100W Standard B Tri-proof	100W	10000LM	100LM/W	Ra>80	AC100-277V	PF>0.95	IP65 / IK10



Premium Range : 125LM/W

Order Code	ProductName	Rated Power	Lumen Output	Lumen Efficacy	Color Index	AC Input	Power Factor	IP/IK Class
TR02-22PN1-BFN1X-500	2ft/22W Premium B Tri-proof	22W	2750LM	125LM/W	Ra>80	AC100-277V	PF>0.95	IP65 / IK10
TR04-40PN1-BFN1X-500	4ft/40W Premium B Tri-proof	40W	5000LM	125LM/W	Ra>80	AC100-277V	PF>0.95	IP65 / IK10
TR04-60PN1-BFN1X-500	4ft/60W Premium B Tri-proof	60W	7500LM	125LM/W	Ra>80	AC100-277V	PF>0.95	IP65 / IK10
TR05-60PN1-BFN1X-500	5ft/60W Premium B Tri-proof	60W	7500LM	125LM/W	Ra>80	AC100-277V	PF>0.95	IP65 / IK10
TR08-1APN1-BFN1X-500	8ft/100W Premium B Tri-proof	100W	12500LM	125LM/W	Ra>80	AC100-277V	PF>0.95	IP65 / IK10



Deluxe Range : 140LM/W

Order Code	ProductName	Rated Power	Lumen Output	Lumen Efficacy	Color Index	AC Input	Power Factor	IP/IK Class
TR02-22DN1-BFN1X-500	2ft/22W Deluxe B Tri-proof	22W	3050LM	140LM/W	Ra>80	AC100-277V	PF>0.95	IP65 / IK10
TR04-40DN1-BFN1X-500	4ft/40W Deluxe B Tri-proof	40W	5600LM	140LM/W	Ra>80	AC100-277V	PF>0.95	IP65 / IK10
TR04-60DN1-BFN1X-500	4ft/60W Deluxe B Tri-proof	60W	8400LM	140LM/W	Ra>80	AC100-277V	PF>0.95	IP65 / IK10
TR05-60DN1-BFN1X-500	5ft/60W Deluxe B Tri-proof	60W	8400LM	140LM/W	Ra>80	AC100-277V	PF>0.95	IP65 / IK10
TR08-1ADN1-BFN1X-500	8ft/100W Deluxe B Tri-proof	100W	14000LM	140LM/W	Ra>80	AC100-277V	PF>0.95	IP65 / IK10

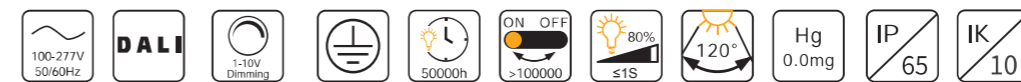

D version Tri-proof Light

EU Style

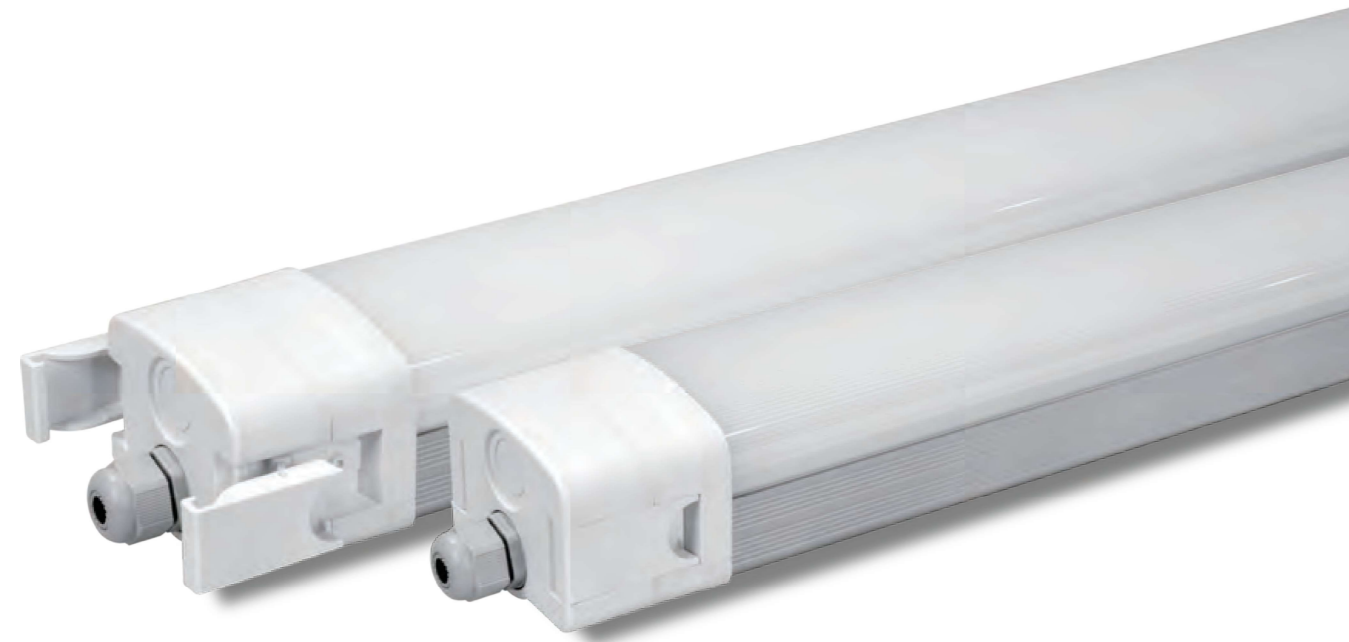

Features

- > Owner design clip end cap for easy installation
- > Special driver tray for replacement
- > IP 65 /IK10 Approval
- > Multiple Link with double wirings
- > Patent aluminum case as heatsink
- > 5 years warranty

Applications

- > Replacement for fluorescent NCF
- > Warehouses , Factories, Car parks
- > Sport facilities, Outdoor & Indoor Locations

Tri-color



Options

- > Dimming : 1-10V / DALI / MS
- > Wiring : Single or double sides
- > Lumen efficacy :
Standard : 100LM/W
Premium : 125LM/W
Deluxe:140LM/W

Dimensions



Product Name	A	B	C
2ft/60cm	625	83.8	62.8
4ft/120cm	1225	83.8	62.8
5ft/150cm	1525	83.8	62.8
8ft/240cm	2425	83.8	62.8

Unit:mm

Standard Range : 100LM/W

Order Code	ProductName	Rated Power	Lumen Output	Lumen Efficacy	Color Index	AC Input	Power Factor	IP/IK Class
TR02-22SN1-DFN1B-001	60CM/22W Standard B Tri-proof	22W	2200LM	100LM/W	Ra>80	AC200-240V	PF>0.95	IP65 / IK10
TR04-40SN1-DFN1B-001	120CM/40W Standard B Tri-proof	40W	4000LM	100LM/W	Ra>80	AC200-240V	PF>0.95	IP65 / IK10
TR04-60SN1-DFN1B-001	120CM/60W Standard B Tri-proof	60W	6000LM	100LM/W	Ra>80	AC200-240V	PF>0.95	IP65 / IK10
TR05-60SN1-DFN1B-001	150CM/60W Standard B Tri-proof	60W	6000LM	100LM/W	Ra>80	AC200-240V	PF>0.95	IP65 / IK10
TR08-1ASN1-DFN1B-001	240CM/100W Standard B Tri-proof	100W	10000LM	100LM/W	Ra>80	AC200-240V	PF>0.95	IP65 / IK10

Premium Range : 125LM/W

Order Code	ProductName	Rated Power	Lumen Output	Lumen Efficacy	Color Index	AC Input	Power Factor	IP/IK Class
TR02-22PN1-DFN1B-001	60CM/22W Premium B Tri-proof	22W	2750LM	125LM/W	Ra>80	AC200-240V	PF>0.95	IP65 / IK10
TR04-40PN1-DFN1B-001	120CM/40W Premium B Tri-proof	40W	5000LM	125LM/W	Ra>80	AC200-240V	PF>0.95	IP65 / IK10
TR04-60PN1-DFN1B-001	120CM/60W Premium B Tri-proof	60W	7500LM	125LM/W	Ra>80	AC200-240V	PF>0.95	IP65 / IK10
TR05-60PN1-DFN1B-001	150CM/60W Premium B Tri-proof	60W	7500LM	125LM/W	Ra>80	AC200-240V	PF>0.95	IP65 / IK10
TR08-1APN1-DFN1B-001	240CM/100W Premium B Tri-proof	100W	12500LM	125LM/W	Ra>80	AC200-240V	PF>0.95	IP65 / IK10

Deluxe Range : 140LM/W

Order Code	ProductName	Rated Power	Lumen Output	Lumen Efficacy	Color Index	AC Input	Power Factor	IP/IK Class
TR02-22DN1-DFN1B-001	60CM/22W Deluxe B Tri-proof	22W	3050LM	140LM/W	Ra>80	AC200-240V	PF>0.95	IP65 / IK10
TR04-40DN1-DFN1B-001	120CM/40W Deluxe B Tri-proof	40W	5600LM	140LM/W	Ra>80	AC200-240V	PF>0.95	IP65 / IK10
TR04-60DN1-DFN1B-001	120CM/60W Deluxe B Tri-proof	60W	8400LM	140LM/W	Ra>80	AC200-240V	PF>0.95	IP65 / IK10
TR05-60DN1-DFN1B-001	150CM/60W Deluxe B Tri-proof	60W	8400LM	140LM/W	Ra>80	AC200-240V	PF>0.95	IP65 / IK10
TR08-1ADN1-DFN1B-001	240CM/100W Deluxe B Tri-proof	100W	14000LM	140LM/W	Ra>80	AC200-240V	PF>0.95	IP65 / IK10

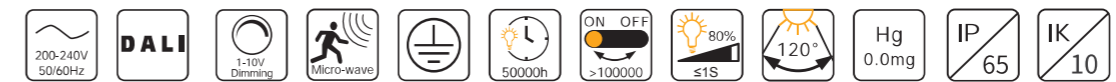

D version Tri-proof Light

North American Style

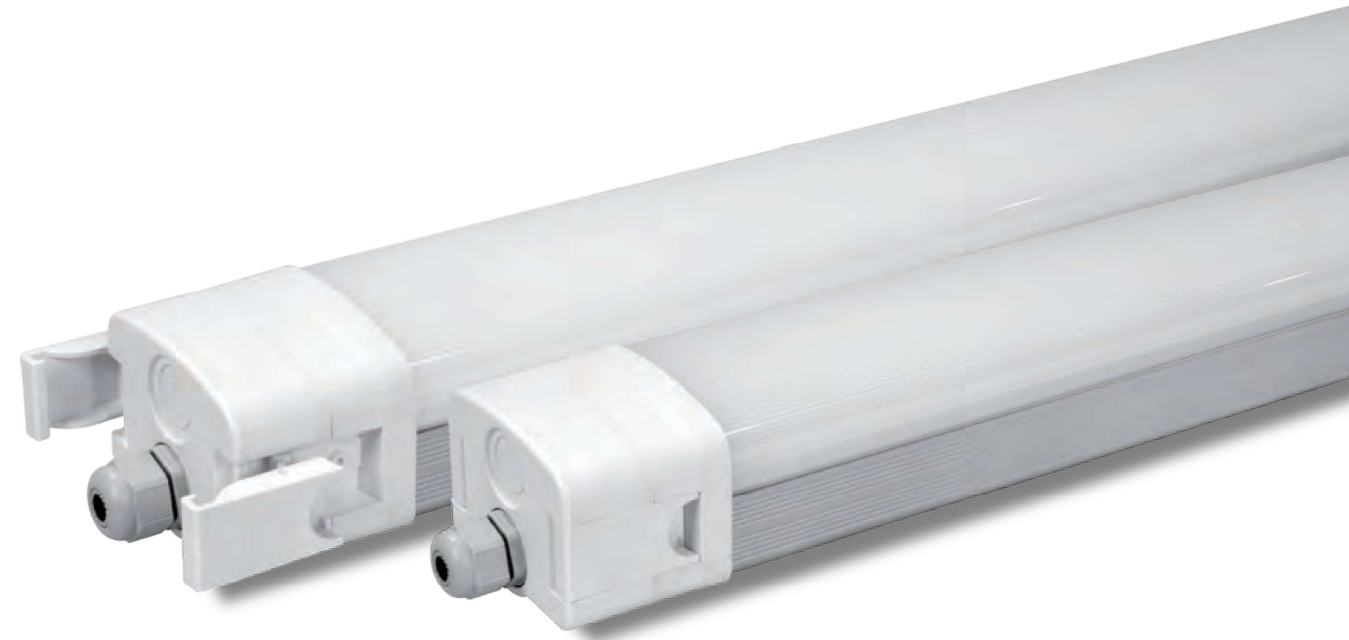

Standard Range : 100LM/W

Order Code	ProductName	Rated Power	Lumen Output	Lumen Efficacy	Color Index	AC Input	Power Factor	IP/IK Class
TR02-22SN1-DFN1X-500	2ft/22W Standard B Tri-proof	22W	2200LM	100LM/W	Ra>80	AC100-277V	PF>0.95	IP65 / IK10
TR04-40SN1-DFN1X-500	4ft/40W Standard B Tri-proof	40W	4000LM	100LM/W	Ra>80	AC100-277V	PF>0.95	IP65 / IK10
TR04-60SN1-DFN1X-500	4ft/60W Standard B Tri-proof	60W	6000LM	100LM/W	Ra>80	AC100-277V	PF>0.95	IP65 / IK10
TR05-60SN1-DFN1X-500	5ft/60W Standard B Tri-proof	60W	6000LM	100LM/W	Ra>80	AC100-277V	PF>0.95	IP65 / IK10
TR08-1ASN1-DFN1X-500	8ft/100W Standard B Tri-proof	100W	10000LM	100LM/W	Ra>80	AC100-277V	PF>0.95	IP65 / IK10

Premium Range : 125LM/W



Order Code	ProductName	Rated Power	Lumen Output	Lumen Efficacy	Color Index	AC Input	Power Factor	IP/IK Class
TR02-22PN1-DFN1X-500	2ft/22W Premium B Tri-proof	22W	2750LM	125LM/W	Ra>80	AC100-277V	PF>0.95	IP65 / IK10
TR04-40PN1-DFN1X-500	4ft/40W Premium B Tri-proof	40W	5000LM	125LM/W	Ra>80	AC100-277V	PF>0.95	IP65 / IK10
TR04-60PN1-DFN1X-500	4ft/60W Premium B Tri-proof	60W	7500LM	125LM/W	Ra>80	AC100-277V	PF>0.95	IP65 / IK10
TR05-60PN1-DFN1X-500	5ft/60W Premium B Tri-proof	60W	7500LM	125LM/W	Ra>80	AC100-277V	PF>0.95	IP65 / IK10
TR08-1APN1-DFN1X-500	8ft/100W Premium B Tri-proof	100W	12500LM	125LM/W	Ra>80	AC100-277V	PF>0.95	IP65 / IK10

Deluxe Range : 140LM/W



Order Code	ProductName	Rated Power	Lumen Output	Lumen Efficacy	Color Index	AC Input	Power Factor	IP/IK Class
TR02-22DN1-DFN1X-500	2ft/22W Deluxe B Tri-proof	22W	3050LM	140LM/W	Ra>80	AC100-277V	PF>0.95	IP65 / IK10
TR04-40DN1-DFN1X-500	4ft/40W Deluxe B Tri-proof	40W	5600LM	140LM/W	Ra>80	AC100-277V	PF>0.95	IP65 / IK10
TR04-60DN1-DFN1X-500	4ft/60W Deluxe B Tri-proof	60W	8400LM	140LM/W	Ra>80	AC100-277V	PF>0.95	IP65 / IK10
TR05-60DN1-DFN1X-500	5ft/60W Deluxe B Tri-proof	60W	8400LM	140LM/W	Ra>80	AC100-277V	PF>0.95	IP65 / IK10
TR08-1ADN1-DFN1X-500	8ft/100W Deluxe B Tri-proof	100W	14000LM	140LM/W	Ra>80	AC100-277V	PF>0.95	IP65 / IK10

IP65 IK10 | 1~10V dimming | 5 YR

Tri-color
3000K | 4000K | 5000K

Features

- > Owner design clip end cap for easy installation
- > Special driver tray for replacement
- > IP 65 /IK10 Approval
- > Multiple Link with double wirings
- > Patent aluminum case as heatsink
- > 5 years warranty

Options

- > Dimming : 1-10V / DALI / MS
- > Wiring : Single or double sides
- > Lumen efficacy :
Standard : 100LM/W
Premium : 125LM/W
Deluxe:140LM/W

Applications

- > Replacement for fluorescent NCF
- > Warehouses , Factories, Car parks
- > Sport facilities, Outdoor & Indoor Locations

Dimensions

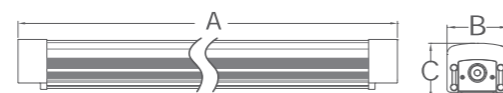

Product Name	A	B	C
2ft/60cm	625	85	78
4ft/120cm	1225	85	78
5ft/150cm	1525	85	78
8ft/240cm	2425	85	78

Unit:mm

100-277V 50/60Hz | DALI | 1-10V Dimming | Micro-wave | 50000h | ON OFF >100000 | 80% ≤1S | 120° | Hg 0.0mg | IP 65 | IK 10



LED Tubar Light

60%
energy saving

50,000
hours life

5 years
warranty

LED Tubar Light

IP65 with Rotatable Clip Premium :120-130LM/W Deluxe:140-150LM/W



Rotatable clip

IP 65 1~10V dimming 5 YR

Tri-color
3000K 4000K 5000K

Features

- > Patent design IP65 case
- > 180 degree Rotatable after installation
- > Multiple link with IP65 connector
- > Tri-color switch inside end cap
- > Up to 60% energy saving

Options

- > Emitting color :
Single color or Tri-color
- > Dimming:
ON-OFF or 1-10V Dimming
- > AC input
AC200-240V or AC100-277V

Applications

- > Replacement for normal T8 fluorescent
- > Replacement for normal NCF
- > Walkways and Stairwells
- > General amenities and Security areas
- > Mirror Lights

Photometry Curve

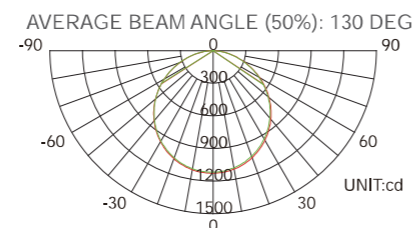

EU Style

• Data Sheet

Order Code	Product Name	Rated Power	Lumen Output	Lumen Efficacy	Color Index	AC Input	Power Factor	Flicker Free	IP Class
Premium Version : 120-130 LM/W									
TU02-12PN1-FMN1B-001	60CM-12W premium tubar	12W	1450LM	120LM/W	Ra>80	AC200-240V	PF>0.95	Y	IP65
TU03-16PN1-FMN1B-001	80CM-16W premium tubar	16W	1950LM	120LM/W	Ra>80	AC200-240V	PF>0.95	Y	IP65
TU05-30PN1-FMN1B-001	150CM-30W premium tubar	30W	3600LM	120LM/W	Ra>80	AC200-240V	PF>0.95	Y	IP65
Deluxe version : 140-150 LM/W									
TU02-12DN1-FMN1B-001	60CM-12W deluxe tubar	12W	1650LM	140LM/W	Ra>80	AC200-240V	PF>0.95	Y	IP65
TU03-16DN1-FMN1B-001	80CM-16W deluxe tubar	16W	2250LM	140LM/W	Ra>80	AC200-240V	PF>0.95	Y	IP65
TU05-30DN1-FMN1B-001	150CM-30W deluxe tubar	30W	4200LM	140LM/W	Ra>80	AC200-240V	PF>0.95	Y	IP65

200-240V 50/60Hz ON OFF >100000 1-10V Dimming 50000h 80% ≤1S 130° Hg 0.0mg IP 65

North American Style

• Data Sheet

Order Code	Product Name	Rated Power	Lumen Output	Lumen Efficacy	Color Index	AC Input	Power Factor	Flicker Free	IP Class
Premium Version : 120-130 LM/W									
TU02-12PN1-FMN1B-500	60CM-12W premium tubar	12W	1450LM	120LM/W	Ra>80	AC100-277V	PF>0.95	Y	IP65
TU03-16PN1-FMN1B-500	80CM-16W premium tubar	16W	1950LM	120LM/W	Ra>80	AC100-277V	PF>0.95	Y	IP65
TU05-30PN1-FMN1B-500	150CM-30W premium tubar	30W	3600LM	120LM/W	Ra>80	AC100-277V	PF>0.95	Y	IP65
Deluxe version : 140-150 LM/W									
TU02-12DN1-FMN1B-500	60CM-12W deluxe tubar	12W	1650LM	140LM/W	Ra>80	AC100-277V	PF>0.95	Y	IP65
TU03-16DN1-FMN1B-500	80CM-16W deluxe tubar	16W	2250LM	140LM/W	Ra>80	AC100-277V	PF>0.95	Y	IP65
TU05-30DN1-FMN1B-500	150CM-30W deluxe tubar	30W	4200LM	140LM/W	Ra>80	AC100-277V	PF>0.95	Y	IP65

100-277V 50/60Hz ON OFF >100000 1-10V Dimming 50000h 80% ≤1S 130° Hg 0.0mg IP 65

Dimensions

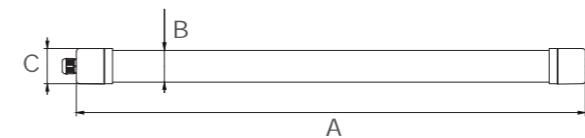

Product Name	A	B	C
60cm/2ft	600	50	55
80cm/4ft	800	50	55
150cm/5ft	1500	50	55

Unit: mm



LED Panel Light LED Troffer Light

60%
energy saving

50,000
hours life

5 years
warranty

P02 Series: Basic LED Panel

HB / Non-fireproof PS LGP UGR>19

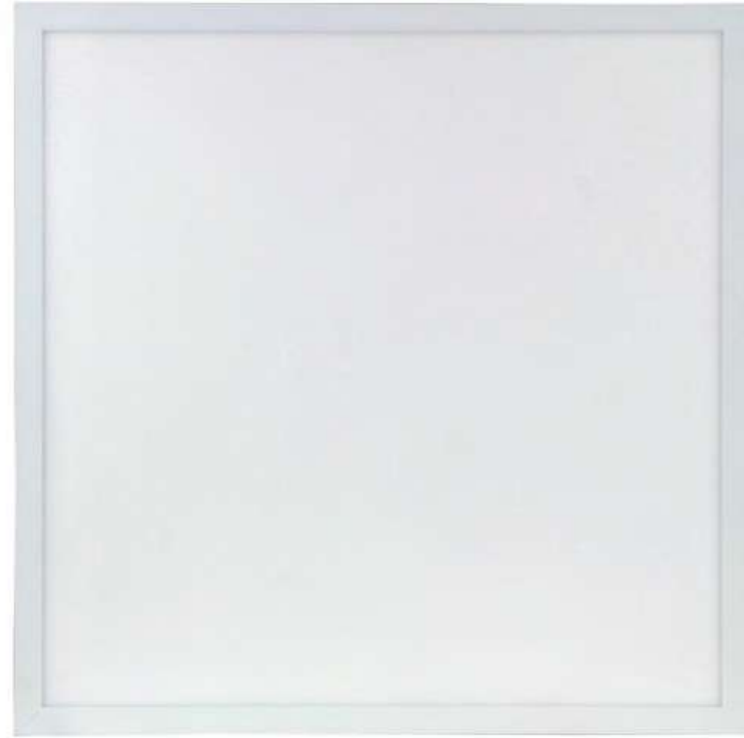

PS
LGP

2YR

Features

- > SMD4014 as light source
- > 2.0mm PS LGP as light guide
- > Extra thin aluminum frame
- > 2 years warranty

Options

- > Lumen efficacy :
Eco : 85 LM/W
Standard : 100LM/W
- > Flicker : Yes or No
- > Emitting color : Single color as standard
- > Installation : Recessed / surface mounting / suspension

Applications

- > Replacement for fluorescent grid
- > Office/School
- > Hospitals /Retail
- > Corridors /Stairwells

Dimension

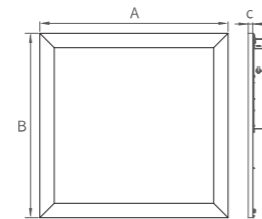

Product Name	A	B	C
600x600	595	595	10
620x620	620	620	10
300x1200	295	1195	10
600x1200	595	1195	10

Unit:mm

Eco Range:85 lm/w HB /PS LGP

• Data Sheet

Order Code	Product Name	Rated Power	Lumen Output	Lumen Efficacy	Color Index	Light Guide	AC Input	Power Factor	Flicker Free
PN22-32EN1- FNN2H-001	600 x600/32W Eco range Basic panel	32W	2700LM	85LM/W	Ra>80	PS	AC200-240V	PF>0.95	N
PN22-40EN1- FNN2H-001	600x600/40W Eco range Basic panel	40W	3400LM	85LM/W	Ra>80	PS	AC200-240V	PF>0.95	N
PN41-32EN1- FNN2H-001	300x1200/32W Eco range Basic panel	32W	2700LM	85LM/W	Ra>80	PS	AC200-240V	PF>0.95	N
PN41-40EN1- FNN2H-001	300x1200/40W Eco range Basic panel	40W	3400LM	85LM/W	Ra>80	PS	AC200-240V	PF>0.95	N
PN62-32EN1- FNN2H-001	620x620/32W Eco range Basic panel	32W	2700LM	85LM/W	Ra>80	PS	AC200-240V	PF>0.95	N
PN62-40EN1- FNN2H-001	620x620/40W Eco range Basic panel	40W	3400LM	85LM/W	Ra>80	PS	AC200-240V	PF>0.95	N
PN42-60EN1- FNN2H-001	600x1200/60W Eco range Basic panel	60W	5100LM	85LM/W	Ra>80	PS	AC200-240V	PF>0.95	N

Standard Range: 100 lm/w HB/PS LGP

• Data Sheet

Order Code	Product Name	Rated Power	Lumen Output	Lumen Efficacy	Color Index	Light Guide	AC Input	Power Factor	Flicker Free
PN22-32SN1- FNN2H-001	600 x600/32W Standard range Basic panel	32W	3200LM	100LM/W	Ra>80	PS	AC200-240V	PF>0.95	N
PN22-40SN1- FNN2H-001	600 x600/40W Standard range Basic panel	40W	4000LM	100LM/W	Ra>80	PS	AC200-240V	PF>0.95	N
PN41-32SN1- FNN2H-001	300x1200/32W Standard range Basic panel	32W	3200LM	100LM/W	Ra>80	PS	AC200-240V	PF>0.95	N
PN41-40SN1- FNN2H-001	300x1200/40W Standard range Basic panel	40W	4000LM	100LM/W	Ra>80	PS	AC200-240V	PF>0.95	N
PN62-32SN1- FNN2H-001	620x620/32W Standard range Basic panel	32W	3200LM	100LM/W	Ra>80	PS	AC200-240V	PF>0.95	N
PN62-40SN1- FNN2H-001	620x620/40W Standard range Basic panel	40W	4000LM	100LM/W	Ra>80	PS	AC200-240V	PF>0.95	N
PN42-60SN1- FNN2H-001	600x1200/60W Standard range Basic panel	60W	6000LM	100LM/W	Ra>80	PS	AC200-240V	PF>0.95	N



P04 Series: Mod LED Panel

HB / Non-fireproof, PMMA LGP UGR >19



PMMA LGP 1~10V dimming 5 YR

Tri-color
3000K 4000K 5000K

Features

- > SMD4014 as light source
- > PMMA LGP as light guide
- > Extra thin aluminum frame
- > 5 years warranty

Options

- > Lumen efficacy :
Standard : 100LM/W
Premium : 120LM/W
- > Dimming : on-off / 1-10V / DALI
- > Emitting color : Single or Tri-color
- > Installation : Recessed / surface mounting / suspension

Applications

- > Replacement for fluorescent grid
- > Office/ school
- > Hospitals /Retail
- > Corridors /Stairwells

Dimensions

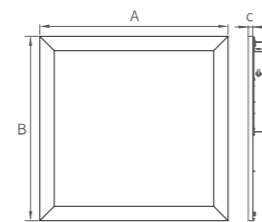

Product Name	A	B	C
600x600	595	595	10
620x620	620	620	10
300x1200	295	1195	10
600x1200	595	1195	10

Unit:mm

Standard Range: 100 lm/w HB /PMMA LGP

• Data Sheet

Order Code	Product Name	Rated Power	Lumen Output	Lumen Efficacy	Color Index	Light Guide	AC Input	Power Factor	Flicker Free
PN22-32SN1- FNN1B-001	600 x600/32W Standard mod panel	32W	3200LM	100LM/W	Ra>80	PMMA	AC200-240V	PF>0.95	Y
PN22-40SN1- FNN1B-001	600x600/40W Standard mod panel	40W	4000LM	100LM/W	Ra>80	PMMA	AC200-240V	PF>0.95	Y
PN41-32SN1- FNN1B-001	300x1200/32W Standard mod panel	32W	3200LM	100LM/W	Ra>80	PMMA	AC200-240V	PF>0.95	Y
PN41-40SN1- FNN1B-001	300x1200/40W Standard mod panel	40W	4000LM	100LM/W	Ra>80	PMMA	AC200-240V	PF>0.95	Y
PN62-32SN1- FNN1B-001	620x620/32W Standard mod panel	32W	3200LM	100LM/W	Ra>80	PMMA	AC200-240V	PF>0.95	Y
PN62-40SN1- FNN1B-001	620x620/40W Standard mod panel	40W	4000LM	100LM/W	Ra>80	PMMA	AC200-240V	PF>0.95	Y
PN42-60SN1- FNN1B-001	600x1200/60W Standard mod panel	60W	6000LM	100LM/W	Ra>80	PMMA	AC200-240V	PF>0.95	Y

Premium Range: 120 lm/w HB/PMMA LGP

• Data Sheet

Order Code	Product Name	Rated Power	Lumen Output	Lumen Efficacy	Color Index	Light Guide	AC Input	Power Factor	Flicker Free
PN22-32PN1- FNN1B-001	600 x600/32W Premium mod panel	32W	3840LM	120LM/W	Ra>80	PMMA	AC200-240V	PF>0.95	Y
PN22-40PN1- FNN1B-001	600 x600/40W Premium mod panel	40W	4800LM	120LM/W	Ra>80	PMMA	AC200-240V	PF>0.95	Y
PN41-32PN1- FNN1B-001	300x1200/32W Premium mod panel	32W	3840LM	120LM/W	Ra>80	PMMA	AC200-240V	PF>0.95	Y
PN41-40PN1- FNN1B-001	300x1200/40W Premium mod panel	40W	4800LM	120LM/W	Ra>80	PMMA	AC200-240V	PF>0.95	Y
PN62-32PN1- FNN1B-001	620x620/32W Premium mod panel	32W	3840LM	120LM/W	Ra>80	PMMA	AC200-240V	PF>0.95	Y
PN62-40PN1- FNN1B-001	620x620/40W Premium mod panel	40W	4800LM	120LM/W	Ra>80	PMMA	AC200-240V	PF>0.95	Y
PN42-60PN1- FNN1B-001	600x1200/60W Premium mod panel	60W	7200LM	120LM/W	Ra>80	PMMA	AC200-240V	PF>0.95	Y



P06 Series: Prismatic LED Panel

Prismatic UGR<19, HB / Non-fireproof



PMMA
LGP

UGR
<19

5 YR

Tri-color

3000K 4000K 5000K

Features

- > Prismatic UGR<19
- > SMD4014 as light source
- > PMMA LGP as light guide
- > Extra thin aluminum frame
- > 5 years warranty

Options

- > Lumen efficacy :
Standard : 100LM/W
Premium : 120LM/W
- > Dimming : on-off / 1-10V / DALI
- > Emitting color : Single or Tri-color
- > Installation : Recessed / surface mounting / suspension

Applications

- > Replacement for fluorescent grid
- > Office/School
- > Hospitals /Retail
- > Corridors /Stairwells

Dimensions

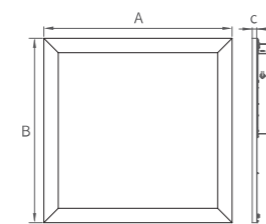

Product Name	A	B	C
600x600	595	595	10
620x620	620	620	10
300x1200	295	1195	10
600x1200	595	1195	10

Unit:mm

Standard Range: 100 lm/w Prismatic UGR<19

• Data Sheet

Order Code	Product Name	Rated Power	Lumen Output	Lumen Efficacy	Color Index	Light Guide	AC Input	Power Factor	Flicker Free
PN22-32SN1-FPN1B-001	600 x600/32W Standard prismatic panel	32W	3200LM	100LM/W	Ra>80	PMMA	AC200-240V	PF>0.95	Y
PN22-40SN1-FPN1B-001	600 x600/40W Standard prismatic panel	40W	4000LM	100LM/W	Ra>80	PMMA	AC200-240V	PF>0.95	Y
PN41-32SN1-FPN1B-001	300x1200/32W Standard prismatic panel	32W	3200LM	100LM/W	Ra>80	PMMA	AC200-240V	PF>0.95	Y
PN41-40SN1-FPN1B-001	300x1200/40W Standard prismatic panel	40W	4000LM	100LM/W	Ra>80	PMMA	AC200-240V	PF>0.95	Y
PN62-32SN1-FPN1B-001	620x620/32W Standard prismatic panel	32W	3200LM	100LM/W	Ra>80	PMMA	AC200-240V	PF>0.95	Y
PN62-40SN1-FPN1B-001	620x620/40W Standard prismatic panel	40W	4000LM	100LM/W	Ra>80	PMMA	AC200-240V	PF>0.95	Y
PN42-60SN1-FPN1B-001	600x1200/60W Standard prismatic panel	60W	6000LM	100LM/W	Ra>80	PMMA	AC200-240V	PF>0.95	Y

Premium Range: 120 lm/w Prismatic UGR<19

• Data Sheet

Order Code	Product Name	Rated Power	Lumen Output	Lumen Efficacy	Color Index	Light Guide	AC Input	Power Factor	Flicker Free
PN22-32PN1-FPN1B-001	600 x600/32W Premium prismatic panel	32W	3850LM	120LM/W	Ra>80	PMMA	AC200-240V	PF>0.95	Y
PN22-40PN1-FPN1B-001	600 x600/40W Premium prismatic panel	40W	4800LM	120LM/W	Ra>80	PMMA	AC200-240V	PF>0.95	Y
PN41-32PN1-FPN1B-001	300x1200/32W Premium prismatic panel	32W	3850LM	120LM/W	Ra>80	PMMA	AC200-240V	PF>0.95	Y
PN41-40PN1-FPN1B-001	300x1200/40W Premium prismatic panel	40W	4800LM	120LM/W	Ra>80	PMMA	AC200-240V	PF>0.95	Y
PN62-32PN1-FPN1B-001	620x620/32W Premium prismatic panel	32W	3850LM	120LM/W	Ra>80	PMMA	AC200-240V	PF>0.95	Y
PN62-40PN1-FPN1B-001	620x620/40W Premium prismatic panel	40W	4800LM	120LM/W	Ra>80	PMMA	AC200-240V	PF>0.95	Y
PN42-60PN1-FPN1B-001	600x1200/60W Premium prismatic panel	60W	7200LM	120LM/W	Ra>80	PMMA	AC200-240V	PF>0.95	Y

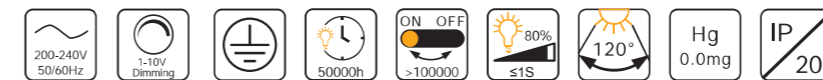

P08 Series : Foil LED Panel

Foil UGR<19 HB/Non-fireproof



PMMA LGP FULL UGR<19 5 YR

Tri-color
3000K 4000K 5000K

Features

- > Foil UGR<19 (full)
- > SMD4014 as light source
- > PMMA LGP as light guide
- > Extra thin aluminum frame
- > 5 years warranty

Options

- > Lumen efficacy :
Standard : 100LM/W
Premium : 120LM/W
- > Dimming : on-off / 1-10V / DALI
- > Emitting color : Single or Tri-color
- > Installation : Recessed / surface mounting / suspension

Applications

- > Replacement for fluroescent grid
- > Office/School
- > Hosptials /Retails
- > Corridors /Stairwells

Dimensions

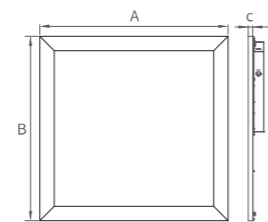

Product Name	A	B	C
600x600	595	595	10
620x620	620	620	10
300x1200	295	1195	10
600x1200	595	1195	10

Unit:mm

Standard Range: 100 lm/w Foil UGR<19



Data Sheet

Order Code	Product Name	Rated Power	Lumen Output	Lumen Efficacy	Color Index	Light Guide	AC Input	Power Factor	Flicker Free
PN22-32SN1- FFN1B-001	600 x600/32W Standard foil panel	32W	3200LM	100LM/W	Ra>80	PMMA	AC200-240V	PF>0.95	Y
PN22-40SN1- FFN1B-001	600 x600/40W Standard foil panel	40W	4000LM	100LM/W	Ra>80	PMMA	AC200-240V	PF>0.95	Y
PN41-32SN1- FFN1B-001	300x1200/32W Standard foil panel	32W	3200LM	100LM/W	Ra>80	PMMA	AC200-240V	PF>0.95	Y
PN41-40SN1- FFN1B-001	300x1200/40W Standard foil panel	40W	4000LM	100LM/W	Ra>80	PMMA	AC200-240V	PF>0.95	Y
PN62-32SN1- FFN1B-001	620x620/32W Standard foil panel	32W	3200LM	100LM/W	Ra>80	PMMA	AC200-240V	PF>0.95	Y
PN62-40SN1- FFN1B-001	620x620/40W Standard foil panel	40W	4000LM	100LM/W	Ra>80	PMMA	AC200-240V	PF>0.95	Y
PN42-60SN1- FFN1B-001	600x1200/60W Standard foil panel	60W	6000LM	100LM/W	Ra>80	PMMA	AC200-240V	PF>0.95	Y

Premium Range: 120 lm/w Foil UGR<19



Data Sheet

Order Code	Product Name	Rated Power	Lumen Output	Lumen Efficacy	Color Index	Light Guide	AC Input	Power Factor	Flicker Free
PN22-32PN1- FFN1B-001	600 x600/32W Premium foil panel	32W	3850LM	120LM/W	Ra>80	PMMA	AC200-240V	PF>0.95	Y
PN22-40PN1- FFN1B-001	600 x600/40W Premium foil panel	40W	4800LM	120LM/W	Ra>80	PMMA	AC200-240V	PF>0.95	Y
PN41-32PN1- FFN1B-001	300x1200/32W Premium foil panel	32W	3850LM	120LM/W	Ra>80	PMMA	AC200-240V	PF>0.95	Y
PN41-40PN1- FFN1B-001	300x1200/40W Premium foil panel	40W	4800LM	120LM/W	Ra>80	PMMA	AC200-240V	PF>0.95	Y
PN62-32PN1- FFN1B-001	620x620/32W Premium foil panel	32W	3850LM	120LM/W	Ra>80	PMMA	AC200-240V	PF>0.95	Y
PN62-40PN1- FFN1B-001	620x620/40W Premium foil panel	40W	4800LM	120LM/W	Ra>80	PMMA	AC200-240V	PF>0.95	Y
PN42-60PN1- FFN1B-001	600x1200/60W Premium foil panel	60W	7200LM	120LM/W	Ra>80	PMMA	AC200-240V	PF>0.95	Y

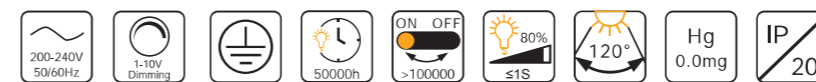

P10 Series :Caxton LED Panel

TP (a) Fire proof UGR>19

Standard Range: 100 lm/w TP(a) /UGR>19

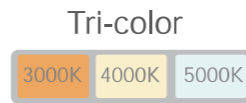
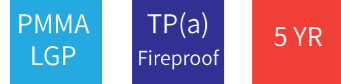

Features

- > TP(a) fireproof with PC diffuser
- > SMD4014 as light source
- > PMMA LGP as light guide
- > Extra thin aluminum frame
- > 5 years warranty

Options

- > Lumen efficacy :
Standard : 100LM/W
Premium : 120LM/W
- > Dimming : on-off / 1-10V / DALI
- > Emitting color : Single or Tri-color
- > Installation : Recessed / surface mounting / suspension

Applications

- > Replacement for fluorescent grid
- > Office/School
- > Hospitals /Retail
- > Corridors /Stairwells

Dimensions

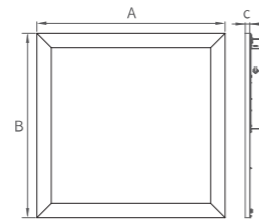

Product Name	A	B	C
600x600	595	595	10
620x620	620	620	10
300x1200	295	1195	10
600x1200	595	1195	10

Unit:mm

• Data Sheet

Order Code	Product Name	Rated Power	Lumen Output	Lumen Efficacy	Color Index	Light Guide	AC Input	Power Factor	Flicker Free
PN22-32SN1- FVN1B-001	600 x600/32W Standard caxton panel	32W	3200LM	100LM/W	Ra>80	PMMA	AC200-240V	PF>0.95	Y
PN22-40SN1- FFN1B-001	600 x600/40W Standard caxton panel	40W	4000LM	100LM/W	Ra>80	PMMA	AC200-240V	PF>0.95	Y
PN41-32SN1- FFN1B-001	300x1200/32W Standard caxton panel	32W	3200LM	100LM/W	Ra>80	PMMA	AC200-240V	PF>0.95	Y
PN41-40SN1- FFN1B-001	300x1200/40W Standard caxton panel	40W	4000LM	100LM/W	Ra>80	PMMA	AC200-240V	PF>0.95	Y
PN62-32SN1- FFN1B-001	620x620/32W Standard caxton panel	32W	3200LM	100LM/W	Ra>80	PMMA	AC200-240V	PF>0.95	Y
PN62-40SN1- FFN1B-001	620x620/40W Standard caxton panel	40W	4000LM	100LM/W	Ra>80	PMMA	AC200-240V	PF>0.95	Y
PN42-60SN1- FFN1B-001	600x1200/60W Standard caxton panel	60W	6000LM	100LM/W	Ra>80	PMMA	AC200-240V	PF>0.95	Y

Premium Range: 120 lm/w TP(a) /UGR>19



• Data Sheet

Order Code	Product Name	Rated Power	Lumen Output	Lumen Efficacy	Color Index	Light Guide	AC Input	Power Factor	Flicker Free
PN22-32PN1- FVN1B-001	600 x600/32W Premium caxton panel	32W	3850LM	120LM/W	Ra>80	PMMA	AC200-240V	PF>0.95	Y
PN22-40PN1- FVN1B-001	600 x600/40W Premium caxton panel	40W	4800LM	120LM/W	Ra>80	PMMA	AC200-240V	PF>0.95	Y
PN41-32PN1- FVN1B-001	300x1200/32W Premium caxton panel	32W	3850LM	120LM/W	Ra>80	PMMA	AC200-240V	PF>0.95	Y
PN41-40PN1- FVN1B-001	300x1200/40W Premium caxton panel	40W	4800LM	120LM/W	Ra>80	PMMA	AC200-240V	PF>0.95	Y
PN62-32PN1- FVN1B-001	620x620/32W Premium caxton panel	32W	3850LM	120LM/W	Ra>80	PMMA	AC200-240V	PF>0.95	Y
PN62-40PN1- FVN1B-001	620x620/40W Premium caxton panel	40W	4800LM	120LM/W	Ra>80	PMMA	AC200-240V	PF>0.95	Y
PN42-60PN1- FVN1B-001	600x1200/60W Premium caxton panel	60W	7200LM	120LM/W	Ra>80	PMMA	AC200-240V	PF>0.95	Y

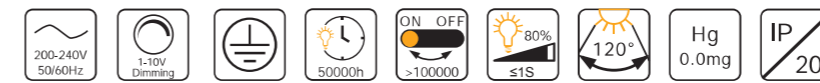

P12 Series Brighton LED Panel

TP (a) Fire proof UGR<19

Standard Range: 100 lm/w TP(a) / UGR<19

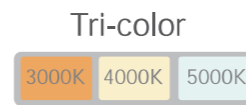
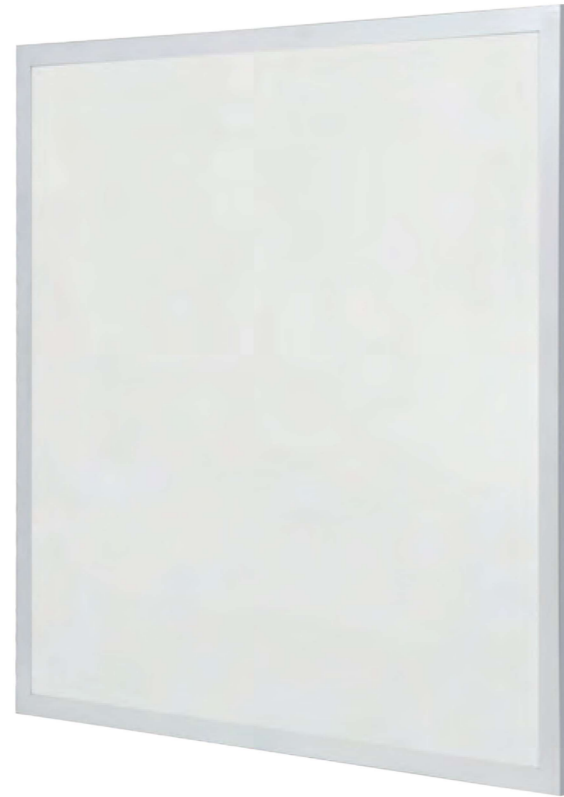

Features

- > TP(a) fireproof with PC diffuser
- > Low glare UGR<19
- > SMD4014 as light source
- > PMMA LGP as light guide
- > Extra thin aluminum frame
- > 5 years warranty

Options

- > Lumen efficacy :
Standard : 100LM/W
Premium : 120LM/W
- > Dimming : on-off / 1-10V / DALI
- > Emitting color : Single or Tri-color
- > Installation : Recessed / surface mounting / suspension

Applications

- > Replacement for fluorescent grid
- > Office/ School
- > Hospitals / Retails
- > Corridors / Stairwells

Dimensions

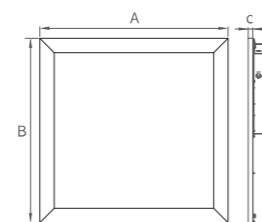

Product Name	A	B	C
600x600	595	595	10
620x620	620	620	10
300x1200	295	1195	10
600x1200	595	1195	10

Unit:mm

• Data Sheet

Order Code	Product Name	Rated Power	Lumen Output	Lumen Efficacy	Color Index	Light Guide	AC Input	Power Factor	Flicker Free
PN22-32SN1-FTN1B-001	600 x600/32W /UGR<19 Standard brighton panel	32W	3200LM	100LM/W	Ra>80	PMMA	AC200-240V	PF>0.95	Y
PN22-40SN1-FTN1B-001	600 x600/40W/UGR<19 Standard brighton panel	40W	4000LM	100LM/W	Ra>80	PMMA	AC200-240V	PF>0.95	Y
PN41-32SN1-FTN1B-001	300x1200/32W/UGR<19 Standard brighton panel	32W	3200LM	100LM/W	Ra>80	PMMA	AC200-240V	PF>0.95	Y
PN41-40SN1-FTN1B-001	300x1200/40W/UGR<19 Standard brighton panel	40W	4000LM	100LM/W	Ra>80	PMMA	AC200-240V	PF>0.95	Y
PN62-32SN1-FTN1B-001	620x620/32W/UGR<19 Standard brighton panel	32W	3200LM	100LM/W	Ra>80	PMMA	AC200-240V	PF>0.95	Y
PN62-40SN1-FTN1B-001	620x620/40W/UGR<19 Standard brighton panel	40W	4000LM	100LM/W	Ra>80	PMMA	AC200-240V	PF>0.95	Y
PN42-60SN1-FTN1B-001	600x1200/60W/UGR<19 Standard brighton panel	60W	6000LM	100LM/W	Ra>80	PMMA	AC200-240V	PF>0.95	Y

Premium Range: 120 lm/w TP(a) /UGR<19



• Data Sheet

Order Code	Product Name	Rated Power	Lumen Output	Lumen Efficacy	Color Index	Light Guide	AC Input	Power Factor	Flicker Free
PN22-32PN1-FTN1B-001	600 x600/32W/UGR<19 Premium brighton panel	32W	3850LM	120LM/W	Ra>80	PMMA	AC200-240V	PF>0.95	Y
PN22-40PN1-FTN1B-001	600 x600/40W/UGR<19 Premium brighton panel	40W	4800LM	120LM/W	Ra>80	PMMA	AC200-240V	PF>0.95	Y
PN41-32PN1-FTN1B-001	300x1200/32W/UGR<19 Premium brighton panel	32W	3850LM	120LM/W	Ra>80	PMMA	AC200-240V	PF>0.95	Y
PN41-40PN1-FTN1B-001	300x1200/40W/UGR<19 Premium brighton panel	40W	4800LM	120LM/W	Ra>80	PMMA	AC200-240V	PF>0.95	Y
PN62-32PN1-FTN1B-001	620x620/32W/UGR<19 Premium brighton panel	32W	3850LM	120LM/W	Ra>80	PMMA	AC200-240V	PF>0.95	Y
PN62-40PN1-FTN1B-001	620x620/40W/UGR<19 Premium brighton panel	40W	4800LM	120LM/W	Ra>80	PMMA	AC200-240V	PF>0.95	Y
PN42-60PN1-FTN1B-001	600x1200/60W/UGR<19 Premium brighton panel	60W	7200LM	120LM/W	Ra>80	PMMA	AC200-240V	PF>0.95	Y

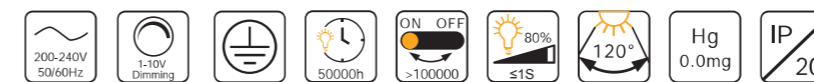

P14 Series ETL LED Panel

ETL / DLC Approval

Standard Range: 100 lm/w ETL/DLC4.4 approval



- PMMA
LGP
- DLC4.4
- 1~10V
dimming
- 5 YR

Features

- > TP(a) fireproof with PC diffuser
- > Low glare UGR<19
- > Flicker free 1-10V dimming
- > SMD4014 as light source
- > PMMA LGP as light guide
- > Extra thin aluminum frame
- > 5 years warranty

Options

- > Lumen efficacy :
Standard : 100LM/W
Premium : 120LM/W
- > Dimming : on-off / 1-10V
- > Installation : Recessed / surface mounting / suspension

Applications

- > Replacement for fluorescent grid
- > Office/ School
- > Hospitals /Retail
- > Corridors /Stairwells

Dimensions

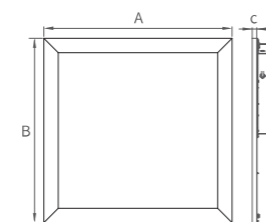

Product Name	A	B	C
2x2ft	603	603	10
1x4ft	303	1212	10
2x4ft	603	1212	10

Unit:mm

• Data Sheet

Order Code	Product Name	Rated Power	Lumen Output	Lumen Efficacy	Color Index	Light Guide	AC Input	Power Factor	Flicker Free
PN22-32SN1- FNV5X-500	2x2ft / 32W ETL standard panel	32W	3200LM	100LM/W	Ra>80	PMMA	AC100-277V	PF>0.95	Y
PN22-40SN1- FNV5X-500	2 x2ft/40W ETL standard panel	40W	4000LM	100LM/W	Ra>80	PMMA	AC100-277V	PF>0.95	Y
PN41-32SN1- FNV5X-500	1X4ft/32W ETL standard panel	32W	3200LM	100LM/W	Ra>80	PMMA	AC100-277V	PF>0.95	Y
PN41-40SN1- FNV5X-500	1X4ft/40W ETL standard panel	40W	4000LM	100LM/W	Ra>80	PMMA	AC100-277V	PF>0.95	Y
PN42-38SN1- FNV5X-500	2x4 ft/38W ETL standard panel	38W	3800LM	100LM/W	Ra>80	PMMA	AC100-277V	PF>0.95	Y
PN42-50SN1- FNV5X-500	2x4 ft/50W ETL standard panel	50W	5000LM	100LM/W	Ra>80	PMMA	AC100-277V	PF>0.95	Y
PN42-60SN1- FNV5X-500	2x4 ft/60W ETL standard panel	60W	6000LM	100LM/W	Ra>80	PMMA	AC200-240V	PF>0.95	Y

Premium Range: 125 lm/w ETL/DLC4.4 approval



• Data Sheet

Order Code	Product Name	Rated Power	Lumen Output	Lumen Efficacy	Color Index	Light Guide	AC Input	Power Factor	Flicker Free
PN22-32PN1- FNV5X-500	2x2ft / 32W ETL premium panel	32W	4000LM	125LM/W	Ra>80	PMMA	AC100-277V	PF>0.95	Y
PN22-40PN1- FNV5X-500	2 x2ft/40W ETL premium panel	40W	5000LM	125LM/W	Ra>80	PMMA	AC100-277V	PF>0.95	Y
PN41-32PN1- FNV5X-500	1X4ft/32W ETL premium panel	32W	4000LM	125LM/W	Ra>80	PMMA	AC100-277V	PF>0.95	Y
PN41-40PN1- FNV5X-500	1X4ft/40W ETL premium panel	40W	5000LM	125LM/W	Ra>80	PMMA	AC100-277V	PF>0.95	Y
PN42-38PN1- FNV5X-500	2x4 ft/38W ETL premium panel	38W	4750LM	125LM/W	Ra>80	PMMA	AC100-277V	PF>0.95	Y
PN42-50PN1- FNV5X-500	2x4 ft/50W ETL premium panel	50W	6250LM	125LM/W	Ra>80	PMMA	AC100-277V	PF>0.95	Y
PN42-60PN1- FNV5X-500	2x4 ft/60W ETL premium panel	60W	7500LM	125LM/W	Ra>80	PMMA	AC100-277V	PF>0.95	Y

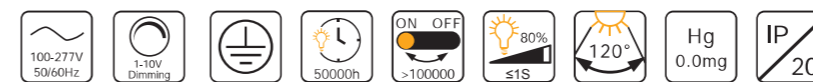

LED Troffer Light

ETL /DLC approval Premium:125LM/W Standard :105LM/W



North American Style

Data Sheet

Order Code	Product Name	Rated Power	Lumen Output	Lumen Efficacy	Color Index	AC Input	Power Factor	Flicker Free
Standard Range 105LM/W								
TF22-30SN1-AMV1X-500	2x2ft ETL troffer	30W	3150LM	105LM/W	Ra>80	AC100-277V	PF>0.95	Y
TF22-40SN1-AMV1X-500	2x2ft ETL troffer	40W	4200LM	105LM/W	Ra>80	AC100-277V	PF>0.95	Y
TF24-50SN1-AMV1X-500	2x4ft ETL troffer	50W	5250LM	105LM/W	Ra>80	AC100-277V	PF>0.95	Y
TF24-60SN1-AMV1X-500	2x4ft ETL troffer	60W	6300LM	105LM/W	Ra>80	AC100-277V	PF>0.95	Y
Premium Range 125LM/W								
TF22-30PN1-AMV1X-500	2x2ft ETL troffer	30W	3750LM	125LM/W	Ra>80	AC100-277V	PF>0.95	Y
TF22-40PN1-AMV1X-500	2x2ft ETL troffer	40W	5000LM	125LM/W	Ra>80	AC100-277V	PF>0.95	Y
TF24-50PN1-AMV1X-500	2x4ft ETL troffer	50W	6250LM	125LM/W	Ra>80	AC100-277V	PF>0.95	Y
TF24-60PN1-AMV1X-500	2x4ft ETL troffer	60W	7500LM	125LM/W	Ra>80	AC100-277V	PF>0.95	Y

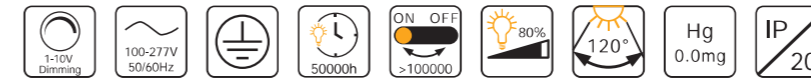

1~10V dimming

5 YR

Features

- > DLC4.4 Approval
- > Steel case as heatsink
- > AC100-277V /1-10V flicker free dimming
- > Quickly terminal for easy wiring

Applications

- > Replacement for fluorescent gird
- > Offices / Schools
- > Hospitals / Retails
- > Corridors / Stairwells

Options

- > Dimming function :
STD ON-OFF / 1-10V dimming
- > LED Driver:
External driver or build-in driver
- > Diffuser :
Mikly or clear
- > Installation: Recessed / suspension

Dimensions

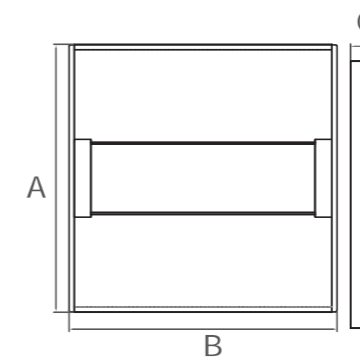

Product Name	A	B	C
2x2ft	603	603	68
2x4ft	603	1212	68

Unit:mm



LED Down Light
LED Slim Down Light

60%
energy saving

50,000
hours life

5 years
warranty

LED Down Light

TP(a) fire proof / IP54



UGR <19 TP(a) IP54 5 YR

Tri-color
3000K 4000K 5000K

Features

- > Low glare / UGR<19
- > Die-case housing as heat sink
- > SMD2835 as light source
- > Flicker free triac dimming
- > 5 years warranty

Application

- > Commerical Lighting:
Shopping mall, Super-market, Hotel, Office
- > Public Lighting:
Path way, Stations, School, Library

Options

- > Emitting Color : Single or Tri-color
- > Dimming: STD ON-OFF / Triac Dimming
- > Fire Rate : TP(a)
- > IP Rate : IP20 or IP54
- > Installation: Recessed / suspension
- > Package : Standard or color box

Tri-Color series



Data Sheet

Order Code	Product Name	Rated Power	Lumen Output	Lumen Efficacy	Color Index	AC Input	Power Factor	IP/ TP Class /TP
DL02-04STR-AVN2B-001	2.5"-4W Down light	4W	400LM	100LM/W	Ra>80	AC200-240V	PF>0.95	IP54/ TP(a)
DL04-07STR-AVN2B-001	4"-7W Down light	7W	700LM	100LM/W	Ra>80	AC200-240V	PF>0.95	IP54/ TP(a)
DL05-10STR-AVN2B-001	5"-10W Down light	10W	1000LM	100LM/W	Ra>80	AC200-240V	PF>0.95	IP54/ TP(a)
DL06-16STR-AVN2B-001	6"-16W Down light	16W	1600LM	100LM/W	Ra>80	AC200-240V	PF>0.95	IP54/ TP(a)
DL08-20STR-AVN2B-001	8"-20W Down light	20W	2000LM	100LM/W	Ra>80	AC200-240V	PF>0.95	IP54/ TP(a)
DL08-30STR-AVN2B-001	8"-30W Down light	30W	3000LM	100LM/W	Ra>80	AC200-240V	PF>0.95	IP54/ TP(a)

Single Color series



Data Sheet

Order Code	Product Name	Rated Power	Lumen Output	Lumen Efficacy	Color Index	AC Input	Power Factor	IP/ TP Class /TP
DL02-04SN1-AVN2B-001	2.5"-4W Down light	4W	400LM	100LM/W	Ra>80	AC200-240V	PF>0.95	IP54/ TP(a)
DL04-07SN1-AVN2B-001	4"-7W Down light	7W	700LM	100LM/W	Ra>80	AC200-240V	PF>0.95	IP54/ TP(a)
DL05-10SN1-AVN2B-001	5"-10W Down light	10W	1000LM	100LM/W	Ra>80	AC200-240V	PF>0.95	IP54/ TP(a)
DL06-16SN1-AVN2B-001	6"-16W Down light	16W	1600LM	100LM/W	Ra>80	AC200-240V	PF>0.95	IP54/ TP(a)
DL08-20SN1-AVN2B-001	8"-20W Down light	20W	2000LM	100LM/W	Ra>80	AC200-240V	PF>0.95	IP54/ TP(a)
DL08-30SN1-AVN2B-001	8"-30W Down light	30W	3000LM	100LM/W	Ra>80	AC200-240V	PF>0.95	IP54/ TP(a)



Dimensions

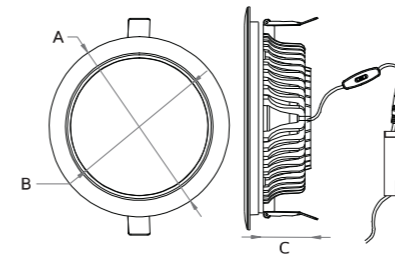

Product Name	A	B	C
2.5" Down Light	Ø95	Ø48	42
4" Down Light	Ø135	Ø89	57
5" Down Light	Ø167	Ø114	59
6" Down Light	Ø195	Ø129	69
8" Down Light	Ø225	Ø163	73

Unit: mm

LED Slim Down Light

Die-case Slim Down Light IP20



Data sheet



Order Code	Product Name	Rated Power	Lumen Output	Lumen Efficacy	Color Index	AC Input	Power Factor	IP Class
PN09-04EN1-RNN2B-001	R90-4W Slim down light	4W	320LM	80LM/W	Ra>80	AC200-240V	PF>0.95	IP20
PN12-08EN1-RNN2B-001	R120-8W Slim down light	8W	650LM	80LM/W	Ra>80	AC200-240V	PF>0.95	IP20
PN14-10EN1-RNN2B-001	R145-10W Slim down light	10W	800LM	80LM/W	Ra>80	AC200-240V	PF>0.95	IP20
PN17-12EN1-RNN2B-001	R170-12W Slim down light	12W	950LM	80LM/W	Ra>80	AC200-240V	PF>0.95	IP20
PN19-18EN1-RNN2B-001	R190-18W Slim down light	18W	1450LM	80LM/W	Ra>80	AC200-240V	PF>0.95	IP20
PN20-18EN1-RNN2B-001	R200-18W Slim down light	18W	1450LM	80LM/W	Ra>80	AC200-240V	PF>0.95	IP20
PN22-18EN1-RNN2B-001	R225-18W Slim down light	18W	1450LM	80LM/W	Ra>80	AC200-240V	PF>0.95	IP20
PN24-18EN1-RNN2B-001	R240-18W Slim down light	18W	1450LM	80LM/W	Ra>80	AC200-240V	PF>0.95	IP20
PN30-22EN1-RNN2B-001	R300-22W Slim down light	22W	1750LM	80LM/W	Ra>80	AC200-240V	PF>0.95	IP20

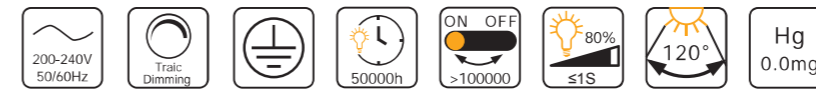

Triac Dimming
IP20
3 YR

Features

- > Slim Design for easy installation
- > Best replacement on CFL/PLL
- > Up to 60% energy savings
- > IP Rating : IP20
- > Easy Recessed installation

Options

- > Dimming: ON-OFF / Triac Dimming
- > Micro-wave sensor: 0% / 30% /100%
- > Installation: Recessed
- > Package : Standard or color box

Applications

- > Commerical Lighting:
Shopping mall, Super-market, Hotel, Office
- > Public Lighting:
Path way , Stations , School , Library

Dimensions

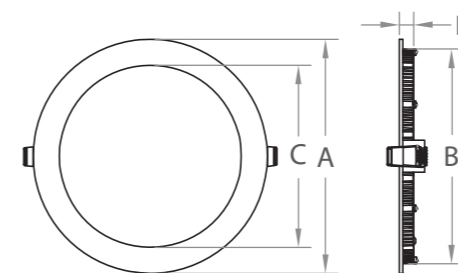

Product Name	A	B	C	D
R90	Ø90	Ø68	Ø50	12
R120	Ø120	Ø107	Ø82	12
R145	Ø145	Ø134	Ø102	12
R170	Ø170	Ø156	Ø127	12
R190	Ø190	Ø175	Ø150	12
R200	Ø200	Ø185	Ø153	12
R225	Ø225	Ø206	Ø176	12
R240	Ø240	Ø225	Ø193	12
R300	Ø295	Ø280	Ø250	12

Unit:mm