

LED HIGH BAY LIGHT SERIES



Features

- 1、LED lamp beads, high transmittance, uniform and soft light effect
- 2、Protection grade IP65,suitable for indoor humid environment and outdoor rain
- 3、This product is suitable for factory buildings, stations, large warehouses, toll stations, gas-stations, exhibition halls, gymnasiums,industrial and mining areas and other semi outdoor and indoor occasions with higher requirements

SR-HBG



60°/90°/120° adjustable lens

Model No	Watts	Size	Lamp beads	Light effect	Color temperature	Voltage	Power Factor	Waterproof level	Pcs
SR-HBG	100W	Ø 249mm	SMD2835	140-190LM/W	3000K-6500K	AC100-277V	>0.95	IP66	1
SR-HBG	150W	Ø 286mm	SMD2835	140-190LM/W	3000K-6500K	AC100-277V	>0.95	IP66	1
SR-HBG	200W	Ø 328mm	SMD2835	140-190LM/W	3000K-6500K	AC100-277V	>0.95	IP66	1



LED HIGH BAY LIGHT SERIES

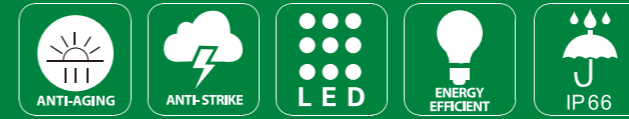

Features

- 1、LED lamp beads, high transmittance, uniform and soft light effect
- 2、Protection grade IP65,suitable for indoor humid environment and outdoor rain
- 3、This product is suitable for factory buildings, stations, large warehouses, toll stations, gas-stations, exhibition halls, gymnasiums,industrial and mining areas and other semi outdoor and indoor occasions with higher requirements

Lamp size unit: mm

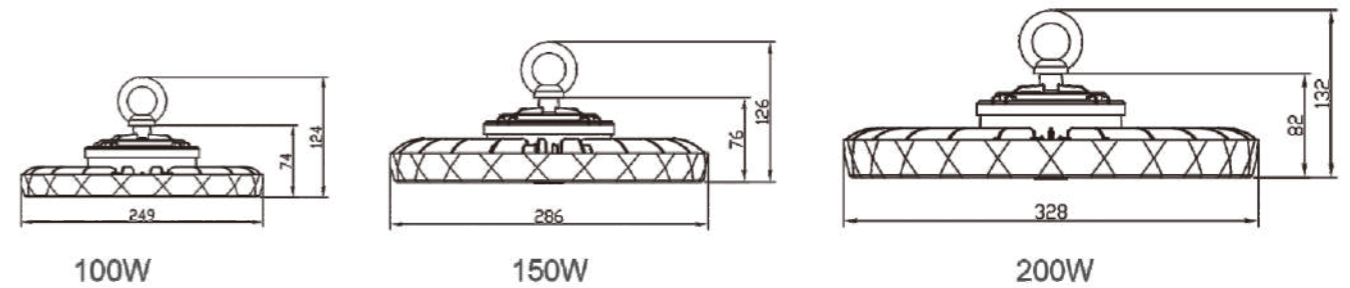

Distribution curve

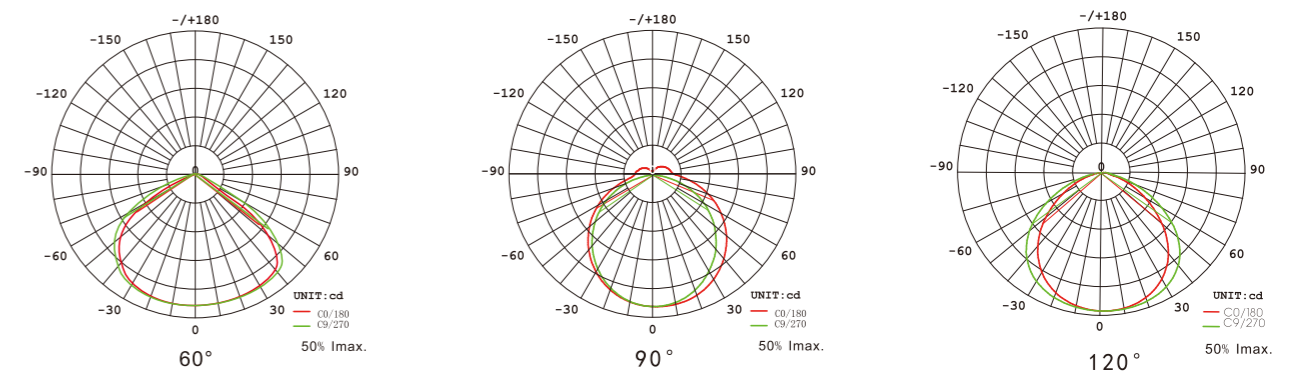

LED HIGH BAY LIGHT SERIES



Features

- 1、 LED lamp beads, high transmittance, uniform and soft light effect
- 2、 Protection grade IP65,suitable for indoor humid environment and outdoor rain
- 3、 This product is suitable for factory buildings, stations, large warehouses, toll stations, gas-stations, exhibition halls, gymnasiums,industrial and mining areas and other semi outdoor and indoor occasions with higher requirements

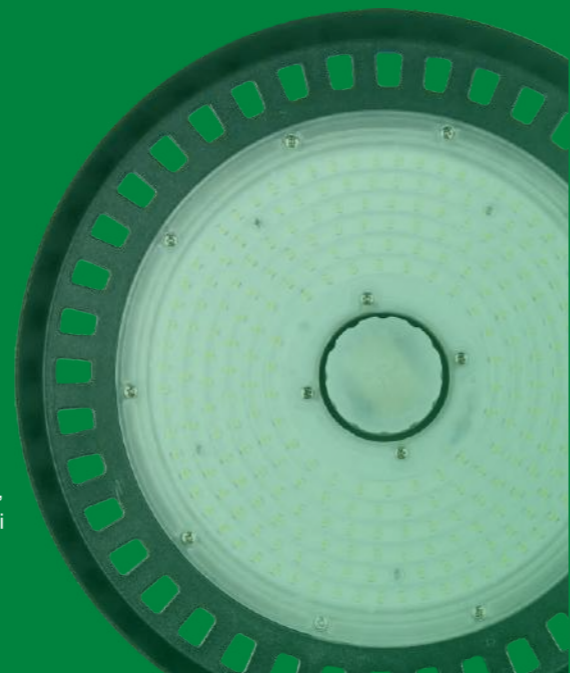

SR-HBD



Model No	Watts	Size	Lamp beads	Light effect	Color temperature	Voltage	Power Factor	Waterproof level	Pcs
SR-HBD100W	100W	Ø253mm	SMD3030	140LM	3000K-6500K	AC100-277V	>0.95	IP66	1
SR-HBD150W	150W	Ø308mm	SMD3030	140LM	3000K-6500K	AC100-277V	>0.95	IP66	1
SR-HBD200W	200W	Ø354mm	SMD3030	140LM	3000K-6500K	AC100-277V	>0.95	IP66	1



LED HIGH BAY LIGHT SERIES



Features

- 1、 LED lamp beads, high transmittance, uniform and soft light effect
- 2、 Protection grade IP65,suitable for indoor humid environment and outdoor rain
- 3、 This product is suitable for factory buildings, stations, large warehouses, toll stations, gas-stations, exhibition halls, gymnasiums,industrial and mining areas and other semi outdoor and indoor occasions with higher requirements



SR-HBM-2



Model No	Watts	Size	Lamp beads	Light effect	Color temperature	Voltage	Power Factor	Waterproof level	Pcs
SR-HBM-2	100W	Ø250mm	SMD2835	150LM/W	3000K-6500K	AC100-277V	>0.95	IP66	1
SR-HBM-2	150W	Ø300mm	SMD2835	150LM/W	3000K-6500K	AC100-277V	>0.95	IP66	1
SR-HBM-2	200W	Ø345mm	SMD2835	150LM/W	3000K-6500K	AC100-277V	>0.95	IP66	1
SR-HBM-2	250W	Ø400mm	SMD2835	150LM/W	3000K-6500K	AC100-277V	>0.95	IP66	1
SR-HBM-2	300W	Ø400mm	SMD2835	150LM/W	3000K-6500K	AC100-277V	>0.95	IP66	1



LED HIGH BAY LIGHT SERIES



Features

- 1、LED lamp beads, high transmittance, uniform and soft light effect
- 2、Protection grade IP65,suitable for indoor humid environment and outdoor rain
- 3、 This product is suitable for factory buildings, stations, large warehouses, toll stations, gas-stations, exhibition halls, gymnasiums,industrial and mining areas and other semi outdoor and indoor occasions with higher requirements

SR-HBW



Model No	Watts	Size	Lamp beads	Light effect	Color temperature	Voltage	Power Factor	Waterproof level	Pcs
SR-HBW100W	100W	Ø255mm	SMD3030	190LM/W	3000K-6500K	AC100-277V	>0.95	IP66	1
SR-HBW150W	150W	Ø305mm	SMD3030	190LM/W	3000K-6500K	AC100-277V	>0.95	IP66	1
SR-HBW200W	200W	Ø360mm	SMD3030	190LM/W	3000K-6500K	AC100-277V	>0.95	IP66	1
SR-HBW300W	300W	Ø405mm	SMD3030	190LM/W	3000K-6500K	AC100-277V	>0.95	IP66	1
SR-HBW500W	500W	Ø500mm	SMD3030	190LM/W	3000K-6500K	AC100-277V	>0.95	IP66	1



LED HIGH BAY LIGHT SERIES

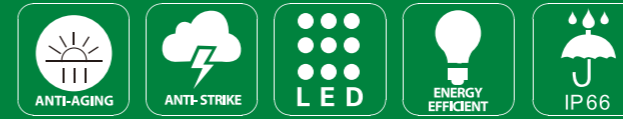

Features

- 1、LED lamp beads, high transmittance, uniform and soft light effect
- 2、Protection grade IP65,suitable for indoor humid environment and outdoor rain
- 3、 This product is suitable for factory buildings, stations, large warehouses, toll stations, gas-stations, exhibition halls, gymnasiums,industrial and mining areas and other semi outdoor and indoor occasions with higher requirements

SR-HBE



Model No	Watts	Size	Lamp beads	Light effect	Color temperature	Voltage	Power Factor	Waterproof level	Pcs
SR-HBE100W	100W	Ø253mm	SMD3030	180LM	3000K-6500K	AC100-277V	>0.95	IP66	1
SR-HBE150W	150W	Ø308mm	SMD3030	180LM	3000K-6500K	AC100-277V	>0.95	IP66	1
SR-HBE200W	200W	Ø354mm	SMD3030	180LM	3000K-6500K	AC100-277V	>0.95	IP66	1



LED HIGH BAY LIGHT SERIES



Features

- 1、 LED lamp beads, high transmittance, uniform and soft light effect
- 2、 Protection grade IP65, suitable for indoor humid environment and outdoor rain
- 3、 This product is suitable for factory buildings, stations, large warehouses, toll stations, gas-stations, exhibition halls, gymnasiums, industrial and mining areas and other semi outdoor and indoor occasions with higher requirements



LED HIGH BAY LIGHT SERIES

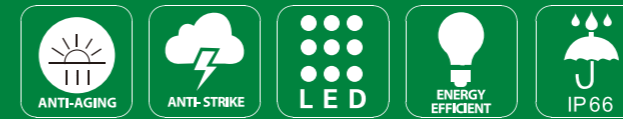

Features

- 1、 LED lamp beads, high transmittance, uniform and soft light effect
- 2、 Protection grade IP65, suitable for indoor humid environment and outdoor rain
- 3、 This product is suitable for factory buildings, stations, large warehouses, toll stations, gas-stations, exhibition halls, gymnasiums, industrial and mining areas and other semi outdoor and indoor occasions with higher requirements



SR-HBV

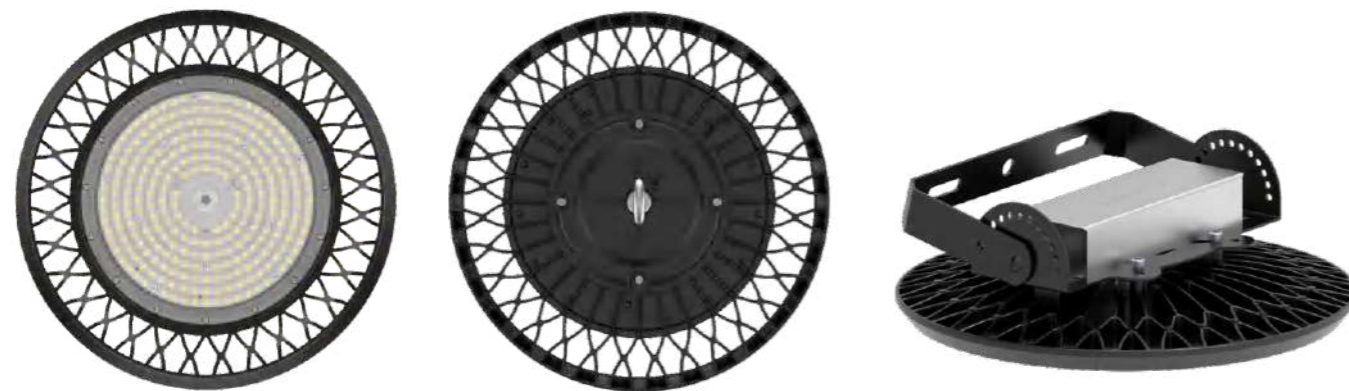

Model No	Watts	Size	Lamp beads	Light effect	Color temperature	Voltage	Power Factor	Waterproof level	Pcs
SR-HBV100W	100W	Ø280mm	SMD3030	140LM	3000K-6500K	AC100-277V	>0.95	IP66	1
SR-HBV150W	150W	Ø340mm	SMD3030	140LM	3000K-6500K	AC100-277V	>0.95	IP66	1
SR-HBV200W	200W	Ø400mm	SMD3030	140LM	3000K-6500K	AC100-277V	>0.95	IP66	1
SR-HBV240W	240W	Ø400mm	SMD3030	140LM	3000K-6500K	AC100-277V	>0.95	IP66	1
SR-HBV300W	300W	Ø440mm	SMD3030	140LM	3000K-6500K	AC100-277V	>0.95	IP66	1



SR-HBM-1



Optional with Various lenses



UFO Annular Lens

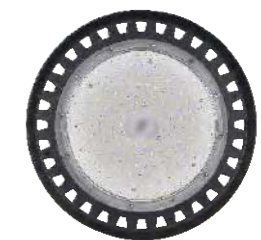

UFO Transparent Lens

Model No	Watts	Size	Lamp beads	Light effect	Color temperature	Voltage	Power Factor	Waterproof level	Pcs
SR-HBM-1	100W	Ø250mm	SMD2835	120LM/W	3000K-6500K	AC100-277V	>0.95	IP66	1
SR-HBM-1	150W	Ø300mm	SMD2835	120LM/W	3000K-6500K	AC100-277V	>0.95	IP66	1
SR-HBM-1	200W	Ø345mm	SMD2835	120LM/W	3000K-6500K	AC100-277V	>0.95	IP66	1
SR-HBM-1	250W	Ø400mm	SMD2835	120LM/W	3000K-6500K	AC100-277V	>0.95	IP66	1
SR-HBM-1	300W	Ø400mm	SMD2835	120LM/W	3000K-6500K	AC100-277V	>0.95	IP66	1



LED HIGH BAY LIGHT SERIES



Features

1. LED lamp beads, high transmittance, uniform and soft light effect
2. Protection grade IP65, suitable for indoor humid environment and outdoor rain
3. This product is suitable for factory buildings, stations, large warehouses, toll stations, gas-stations, exhibition halls, gymnasiums, industrial and mining areas and other semi outdoor and indoor occasions with higher requirements



SR-HBY



Model No	Watts	Size	Lamp beads	Light effect	Color temperature	Voltage	Power Factor	Waterproof level	Pcs
SR-HBY100W	100W	Ø245mm	SMD3030	120LM	3000K-6500K	AC100-265V	≥0.95	IP66	1
SR-HBY150W	150W	Ø280mm	SMD3030	120LM	3000K-6500K	AC100-265V	≥0.95	IP66	1
SR-HBY200W	200W	Ø330mm	SMD3030	120LM	3000K-6500K	AC100-265V	≥0.95	IP66	1



LED HIGH BAY LIGHT SERIES

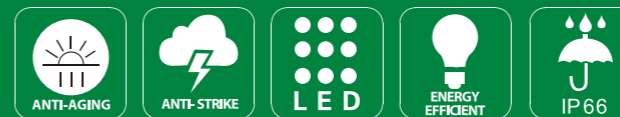

Features

1. LED lamp beads, high transmittance, uniform and soft light effect
2. Protection grade IP65, suitable for indoor humid environment and outdoor rain
3. This product is suitable for factory buildings, stations, large warehouses, toll stations, gas-stations, exhibition halls, gymnasiums, industrial and mining areas and other semi outdoor and indoor occasions with higher requirements



SR-HBZ



Model No	Watts	Size	Lamp beads	Light effect	Color temperature	Voltage	Power Factor	Waterproof level	Pcs
SR-HBZ100W	100W	Ø280mm	SMD3030	140LM	3 COLORS	AC100-277V	>0.95	IP66	1
SR-HBZ150W	150W	Ø330mm	SMD3030	140LM	3 COLORS	AC100-277V	>0.95	IP66	1
SR-HBZ200W	200W	Ø380mm	SMD3030	140LM	3 COLORS	AC100-277V	>0.95	IP66	1



LED HIGH BAY LIGHT SERIES



Features

- 1、LED lamp beads, high transmittance, uniform and soft light effect
- 2、Protection grade IP65,suitable for indoor humid environment and outdoor rain
- 3、This product is suitable for factory buildings, stations, large warehouses, toll stations, gas-stations, exhibition halls, gymnasiums,industrial and mining areas and other semi outdoor and indoor occasions with higher requirements

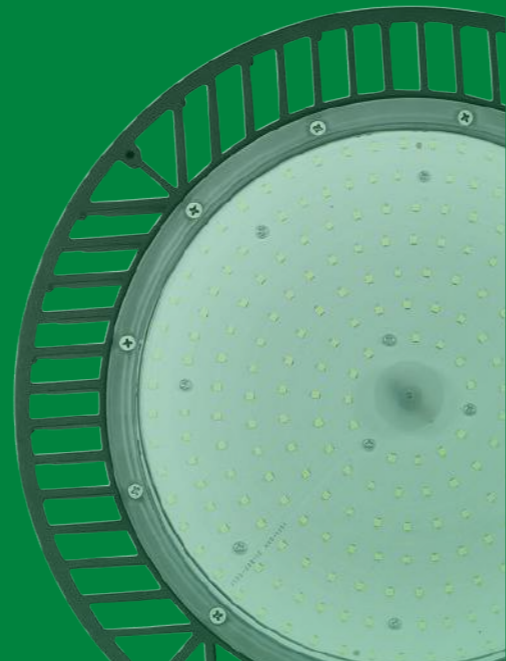

SR-HBS

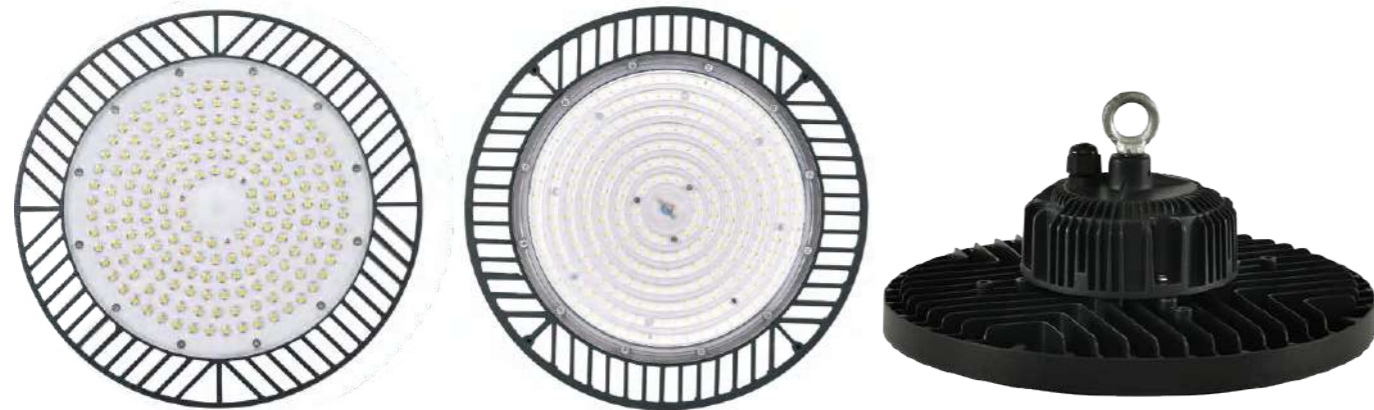

Model No	Watts	Size	Lamp beads	Light effect	Color temperature	Voltage	Power Factor	Waterproof level	Pcs
SR-HBS100W	100W	Ø250mm	SMD3030	120LM	3000K-6500K	AC85-265V	>0.95	IP66	1
SR-HBS150W	150W	Ø300mm	SMD3030	120LM	3000K-6500K	AC85-265V	>0.95	IP66	1
SR-HBS200W	200W	Ø350mm	SMD3030	120LM	3000K-6500K	AC85-265V	>0.95	IP66	1
SR-HBS300W	300W	Ø400mm	SMD3030	120LM	3000K-6500K	AC85-265V	>0.95	IP66	1



LED HIGH BAY LIGHT SERIES

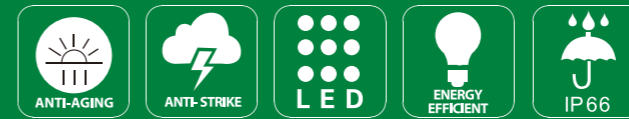

Features

- 1、LED lamp beads, high transmittance, uniform and soft light effect
- 2、Protection grade IP65,suitable for indoor humid environment and outdoor rain
- 3、This product is suitable for factory buildings, stations, large warehouses, toll stations, gas-stations, exhibition halls, gymnasiums,industrial and mining areas and other semi outdoor and indoor occasions with higher requirements



SR-HBF



Model No	Watts	Size	Lamp beads	Light effect	Color temperature	Voltage	Power Factor	Waterproof level	Pcs
SR-HBF100W	100W	Ø280mm	SMD3030	140LM	3000K-6500K	AC100-277V	≥0.95	IP66	1
SR-HBF150W	150W	Ø330mm	SMD3030	140LM	3000K-6500K	AC100-277V	≥0.95	IP66	1
SR-HBF200W	200W	Ø380mm	SMD3030	140LM	3000K-6500K	AC100-277V	≥0.95	IP66	1
SR-HBF240W	240W	Ø380mm	SMD3030	140LM	3000K-6500K	AC100-277V	≥0.95	IP66	1



LED HIGH BAY LIGHT SERIES



Features

- 1、LED lamp beads, high transmittance, uniform and soft light effect
- 2、Protection grade IP65,suitable for indoor humid environment and outdoor rain
- 3、This product is suitable for factory buildings, stations, large warehouses, toll stations, gas-stations, exhibition halls, gymnasiums,industrial and mining areas and other semi outdoor and indoor occasions with higher requirements

SR-HBC



Model No	Watts	Size	Lamp beads	Light effect	Color temperature	Voltage	Power Factor	Waterproof level	Pcs
SR-HBC100W	100W	Ø280mm	SMD2835	110LM	3000K-6500K	AC110/240V	≥0.9	IP66	1
SR-HBC150W	150W	Ø330mm	SMD2835	110LM	3000K-6500K	AC110/240V	≥0.9	IP66	1
SR-HBC200W	200W	Ø380mm	SMD2835	110LM	3000K-6500K	AC110/240V	≥0.9	IP66	1



LED HIGH BAY LIGHT SERIES

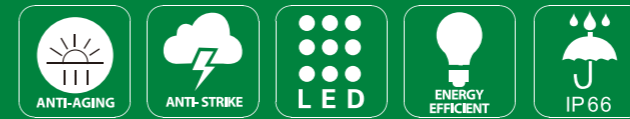

Features

- 1、LED lamp beads, high transmittance, uniform and soft light effect
- 2、Protection grade IP65,suitable for indoor humid environment and outdoor rain
- 3、This product is suitable for factory buildings, stations, large warehouses, toll stations, gas-stations, exhibition halls, gymnasiums,industrial and mining areas and other semi outdoor and indoor occasions with higher requirements

SR-HBL



Model No	Watts	Size	Lamp beads	Light effect	Color temperature	Voltage	Power Factor	Waterproof level	Pcs
SR-HBL100W	100W	Ø245mm	SMD2835	110LM	3000K-6500K	AC85-265V AC110/240V	>0.9	IP66	10
SR-HBL150W	150W	Ø280mm	SMD2835	110LM	3000K-6500K	AC85-265V AC110/240V	>0.9	IP66	10
SR-HBL200W	200W	Ø330mm	SMD2835	110LM	3000K-6500K	AC85-265V AC110/240V	>0.9	IP66	10



LED HIGH BAY LIGHT SERIES



Features

- 1、LED lamp beads, high transmittance, uniform and soft light effect
- 2、Protection grade IP65,suitable for indoor humid environment and outdoor rain
- 3、This product is suitable for factory buildings, stations, large warehouses, toll stations, gas-stations, exhibition halls, gymnasiums,industrial and mining areas and other semi outdoor and indoor occasions with higher requirements

SR-HBP

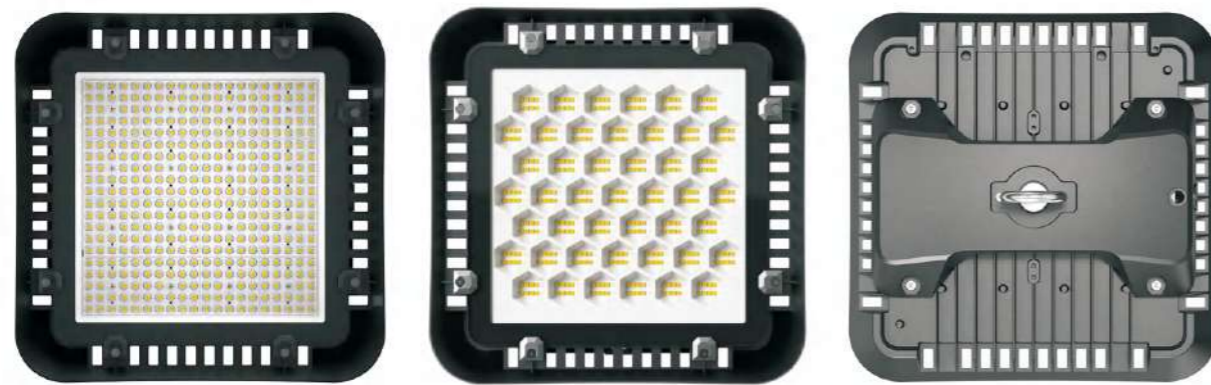

Model No	Watts	Size	Lamp beads	Light effect	Color temperature	Voltage	Power Factor	Waterproof level	Pcs
SR-HBP100W	100W	263*263*45mm	SMD3030	140LM	3000K-6500K	AC100-277V	>0.95	IP66	1
SR-HBP150W	150W	314*314*45mm	SMD3030	140LM	3000K-6500K	AC100-277V	>0.95	IP66	1
SR-HBP200W	200W	314*314*45mm	SMD3030	140LM	3000K-6500K	AC100-277V	>0.95	IP66	1



LED HIGH BAY LIGHT SERIES

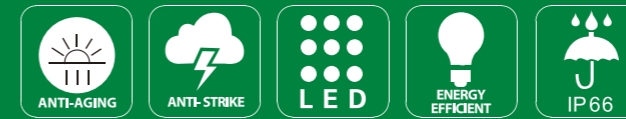

Features

- 1、LED lamp beads, high transmittance, uniform and soft light effect
- 2、Protection grade IP65,suitable for indoor humid environment and outdoor rain
- 3、This product is suitable for factory buildings, stations, large warehouses, toll stations, gas-stations, exhibition halls, gymnasiums,industrial and mining areas and other semi outdoor and indoor occasions with higher requirements

SR-HBO



Model No	Watts	Size	Lamp beads	Light effect	Color temperature	Voltage	Power Factor	Waterproof level	Pcs
SR-HBO100W	100W	Ø280mm	SMD3030	120LM	3000K-6500K	AC100-277V	>0.95	IP66	1
SR-HBO150W	150W	Ø320mm	SMD3030	120LM	3000K-6500K	AC100-277V	>0.95	IP66	1
SR-HBO200W	200W	Ø360mm	SMD3030	120LM	3000K-6500K	AC100-277V	>0.95	IP66	1



LED STREET LAMP SERIES



Features

- 1、 A splicing LED projection lamp, Can be spliced with different wattage, free combination
- 2、 All-aluminum die-cast shell, good heat dissipation, corrosion resistance and no resistance Multiple seals,outdoor waterproof and rustproof
- 3、 Stereo light, large irradiation range, bright light effect, stylish atmosphere



LED STREET LAMP SERIES

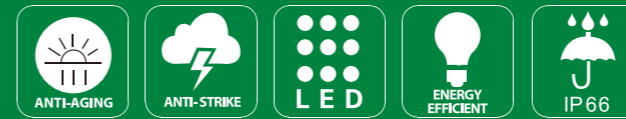

Features

- 1、 A splicing LED projection lamp, Can be spliced with different wattage, free combination
- 2、 All-aluminum die-cast shell, good heat dissipation, corrosion resistance and no resistance Multiple seals,outdoor waterproof and rustproof
- 3、 Stereo light, large irradiation range, bright light effect, stylish atmosphere

SR-FGF



Model No	Watts	Size	Lamp beads	Light effect	Color temperature	Voltage	Power Factor	Waterproof level	Pcs
SR-FGF60W	60W	568*200*109mm	SMD5050	170LM/W	3000K-6500K	AC100-277V	>0.95	IP66	1
SR-FGF100W	120W	613*200*109mm	SMD5050	170LM/W	3000K-6500K	AC100-277V	>0.95	IP66	1
SR-FGF150W	150W	683*260*109mm	SMD5050	170LM/W	3000K-6500K	AC100-277V	>0.95	IP66	1
SR-FGF200W	200W	693*300*109mm	SMD5050	170LM/W	3000K-6500K	AC100-277V	>0.95	IP66	1
SR-FGF300W	300W	793*300*109mm	SMD5050	170LM/W	3000K-6500K	AC100-277V	>0.95	IP66	1

Lamp size unit: mm

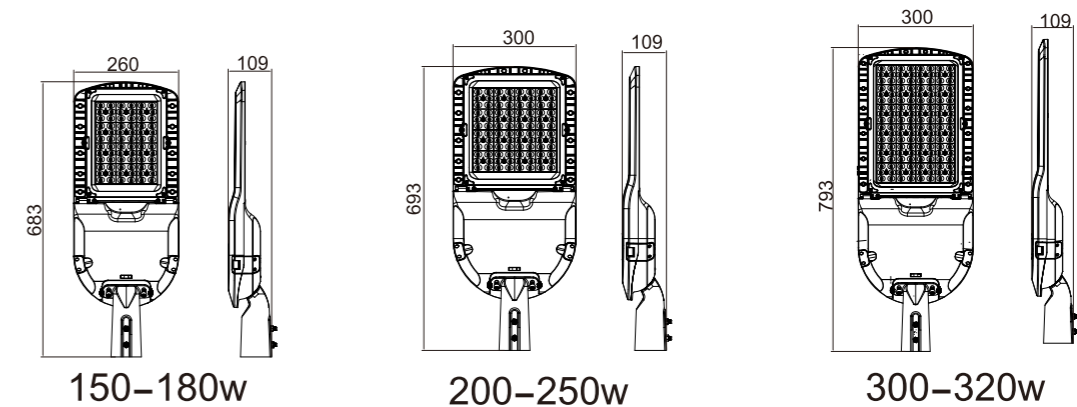

LUMINOUS INTENSITY DISTRIBUTIO

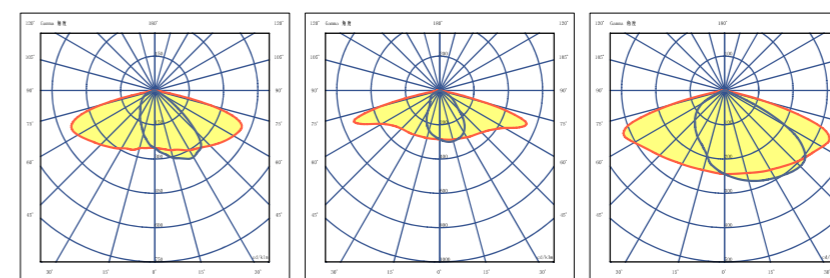

T2S light distribution curve

T2M light distribution curve

T3M light distribution curve



LED STREET LAMP SERIES



Features

- 1、A splicing LED projection lamp, Can be spliced with different wattage, free combination
- 2、 All-aluminum die-cast shell, good heat dissipation, corrosion resistance and no resistance Multiple seals,outdoor waterproof and rustproof
- 3、 Stereo light, large irradiation range, bright light effect, stylish atmosphere



LED STREET LAMP SERIES

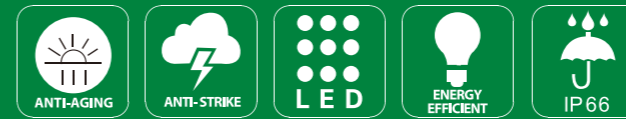

Features

- 1、A splicing LED projection lamp, Can be spliced with different wattage, free combination
- 2、 All-aluminum die-cast shell, good heat dissipation, corrosion resistance and no resistance Multiple seals,outdoor waterproof and rustproof
- 3、 Stereo light, large irradiation range, bright light effect, stylish atmosphere



SR-FGH



Model No	Watts	Size	Lamp beads	Light effect	Color temperature	Voltage	Power Factor	Waterproof level	Pcs
SR-FGH-2	70W-140W	489.7*233.7*72.5mm	SMD3030	210LM/W	3000K-6500K	AC100-277V	>0.95	IP66	1
SR-FGH-3	120W-210W	584.7*279*72.5mm	SMD3030	210LM/W	3000K-6500K	AC100-277V	>0.95	IP66	1
SR-FGH-5	200W-350W	715*278.3*72.5mm	SMD3030	210LM/W	3000K-6500K	AC100-277V	>0.95	IP66	1



SR-FGG



Model No	Watts	Size	Lamp beads	Light effect	Color temperature	Voltage	Power Factor	Waterproof level	Pcs
SR-FGG60W	60W	679*266*130mm	SMD3030	160LM/W	3000K-6500K	AC100-277V	>0.95	IP66	1
SR-FGG100W	100W	845*269*131mm	SMD3030	160LM/W	3000K-6500K	AC100-277V	>0.95	IP66	1
SR-FGG150W	150W	845*269*131mm	SMD3030	160LM/W	3000K-6500K	AC100-277V	>0.95	IP66	1
SR-FGG200W	200W	881*265*129mm	SMD3030	160LM/W	3000K-6500K	AC100-277V	>0.95	IP66	1
SR-FGG250W	250W	881*265*129mm	SMD3030	160LM/W	3000K-6500K	AC100-277V	>0.95	IP66	1



LED STREET LAMP SERIES



Features

- 1、 A splicing LED projection lamp, Can be spliced with different wattage, free combination
- 2、 All-aluminum die-cast shell, good heat dissipation, corrosion resistance and no resistance Multiple seals,outdoor waterproof and rustproof
- 3、 Stereo light, large irradiation range, bright light effect, stylish atmosphere



LED STREET LAMP SERIES

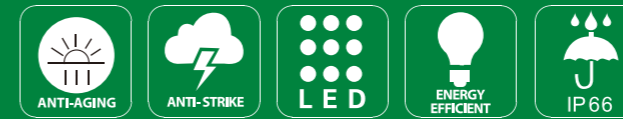

Features

- 1、 A splicing LED projection lamp, Can be spliced with different wattage, free combination
- 2、 All-aluminum die-cast shell, good heat dissipation, corrosion resistance and no resistance Multiple seals,outdoor waterproof and rustproof
- 3、 Stereo light, large irradiation range, bright light effect, stylish atmosphere



SR-FGE



Model No	Watts	Size	Lamp beads	Light effect	Color temperature	Voltage	Power Factor	Waterproof level	Pcs
SR-FGE50W	50W	616.8*250*113.3mm	SMD5050	160LM/W	3000K-6500K	AC100-277V	>0.95	IP66	1
SR-FGE100W	100W	706.8*280*113.3mm	SMD5050	160LM/W	3000K-6500K	AC100-277V	>0.95	IP66	1
SR-FGE150W	150W	783*320*113.3mm	SMD5050	160LM/W	3000K-6500K	AC100-277V	>0.95	IP66	1
SR-FGE200W	200W	783*320*113.3mm	SMD5050	160LM/W	3000K-6500K	AC100-277V	>0.95	IP66	1
SR-FGE240W	240W	783*320*123.3mm	SMD5050	160LM/W	3000K-6500K	AC100-277V	>0.95	IP66	1



SR-FGD



Model No	Watts	Size	Lamp beads	Light effect	Color temperature	Voltage	Power Factor	Waterproof level	Pcs
SR-FGD50W	50W	541*200*113mm	SMD5050	160LM/W	3000K-6500K	AC100-277V	>0.95	IP66	1
SR-FGD100W	100W	602*243*121mm	SMD5050	160LM/W	3000K-6500K	AC100-277V	>0.95	IP66	1
SR-FGD150W	150W	652*263*121mm	SMD5050	160LM/W	3000K-6500K	AC100-277V	>0.95	IP66	1
SR-FGD200W	200W	722*314*121mm	SMD5050	160LM/W	3000K-6500K	AC100-277V	>0.95	IP66	1
SR-FGD240W	240W	823*314*121mm	SMD5050	160LM/W	3000K-6500K	AC100-277V	>0.95	IP66	1



LED STREET LAMP SERIES



Features

- 1、 A splicing LED projection lamp, Can be spliced with different wattage, free combination
- 2、 All-aluminum die-cast shell, good heat dissipation, corrosion resistance and no resistance Multiple seals,outdoor waterproof and rustproof
- 3、 Stereo light, large irradiation range, bright light effect, stylish atmosphere

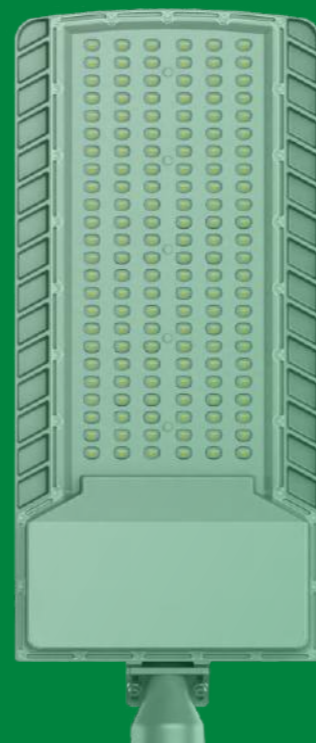

LED STREET LAMP SERIES

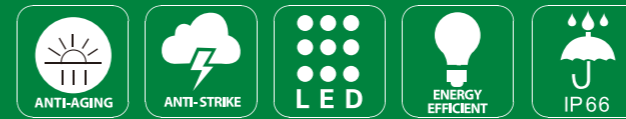

Features

- 1、 A splicing LED projection lamp, Can be spliced with different wattage, free combination
- 2、 All-aluminum die-cast shell, good heat dissipation, corrosion resistance and no resistance Multiple seals,outdoor waterproof and rustproof
- 3、 Stereo light, large irradiation range, bright light effect, stylish atmosphere



SR-STU



Model No	Watts	Size	Lamp beads	Light effect	Color temperature	Voltage	Power Factor	Waterproof level	Pcs
SR-STU30W	30W	438*108*75mm	SMD5050	180LM/W	3000K-6500K	AC100-277V	>0.95	IP66	1
SR-STU50W	50W	467*175*75mm	SMD5050	180LM/W	3000K-6500K	AC100-277V	>0.95	IP66	1
SR-STU100W	100W	564*221*75mm	SMD5050	180LM/W	3000K-6500K	AC100-277V	>0.95	IP66	1
SR-STU150W	150W	647*241*75mm	SMD5050	180LM/W	3000K-6500K	AC100-277V	>0.95	IP66	1
SR-STU200W	200W	740*276*75mm	SMD5050	180LM/W	3000K-6500K	AC100-277V	>0.95	IP66	1



SR-STQ



Model No	Watts	Size	Lamp beads	Light effect	Color temperature	Voltage	Power Factor	Waterproof level	Pcs
SR-STQ50W	50W	560*196*98.5mm	SMD3030	140LM/W	3000K-6500K	AC100-277V	>0.9	IP66	1
SR-STQ100W	100W	610*245*98.5mm	SMD3030	140LM/W	3000K-6500K	AC100-277V	>0.9	IP66	1
SR-STQ150W	150W	661*245*98.5mm	SMD3030	140LM/W	3000K-6500K	AC100-277V	>0.9	IP66	1
SR-STQ200W	200W	712*230*98.5mm	SMD3030	140LM/W	3000K-6500K	AC100-277V	>0.9	IP66	1
SR-STQ300W	300W	714.3*340*97mm	SMD3030	140LM/W	3000K-6500K	AC100-277V	>0.9	IP66	1



LED STREET LAMP SERIES



Features

- 1、 A splicing LED projection lamp, Can be spliced with different wattage, free combination
- 2、 All-aluminum die-cast shell, good heat dissipation, corrosion resistance and no resistance Multiple seals,outdoor waterproof and rustproof
- 3、 Stereo light, large irradiation range, bright light effect, stylish atmosphere



LED STREET LAMP SERIES

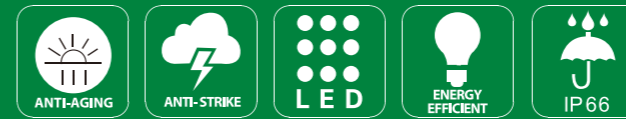

Features

- 1、 A splicing LED projection lamp, Can be spliced with different wattage, free combination
- 2、 All-aluminum die-cast shell, good heat dissipation, corrosion resistance and no resistance Multiple seals,outdoor waterproof and rustproof
- 3、 Stereo light, large irradiation range, bright light effect, stylish atmosphere



SR-FGC



Model No	Watts	Size	Lamp beads	Light effect	Color temperature	Voltage	Power Factor	Waterproof level	Pcs
SR-FGC50W	50W	555*210*143mm	SMD3030	150LM	3000K-6500K	AC100-277V	>0.95	IP66	1
SR-FGC60W	60W	555*210*143mm	SMD3030	150LM	3000K-6500K	AC100-277V	>0.95	IP66	1
SR-FGC80W	80W	645*257*147mm	SMD3030	150LM	3000K-6500K	AC100-277V	>0.95	IP66	1
SR-FGC100W	100W	645*257*147mm	SMD3030	150LM	3000K-6500K	AC100-277V	>0.95	IP66	1
SR-FGC120W	120W	790*305*147mm	SMD3030	150LM	3000K-6500K	AC100-277V	>0.95	IP66	1
SR-FGC150W	150W	790*305*147mm	SMD3030	150LM	3000K-6500K	AC100-277V	>0.95	IP66	1
SR-FGC180W	180W	790*305*147mm	SMD3030	150LM	3000K-6500K	AC100-277V	>0.95	IP66	1
SR-FGC200W	200W	790*305*147mm	SMD3030	150LM	3000K-6500K	AC100-277V	>0.95	IP66	1
SR-FGC250W	250W	890*361*163mm	SMD3030	150LM	3000K-6500K	AC100-277V	>0.95	IP66	1
SR-FGC300W	300W	890*361*163mm	SMD3030	150LM	3000K-6500K	AC100-277V	>0.95	IP66	1



SR-FGB



Model No	Watts	Size	Lamp beads	Light effect	Color temperature	Voltage	Power Factor	Waterproof level	Pcs
SR-FGB30W	30W	641*241*114mm	SMD3030	140LM	3000K-6500K	AC100-277V	>0.95	IP66	1
SR-FGB50W	50W	641*241*114mm	SMD3030	140LM	3000K-6500K	AC100-277V	>0.95	IP66	1
SR-FGB60W	60W	641*241*114mm	SMD3030	140LM	3000K-6500K	AC100-277V	>0.95	IP66	1
SR-FGB80W	80W	738*289*116mm	SMD3030	140LM	3000K-6500K	AC100-277V	>0.95	IP66	1
SR-FGB100W	100W	738*289*116mm	SMD3030	140LM	3000K-6500K	AC100-277V	>0.95	IP66	1
SR-FGB120W	120W	738*289*116mm	SMD3030	140LM	3000K-6500K	AC100-277V	>0.95	IP66	1
SR-FGB150W	150W	922*360*144mm	SMD3030	140LM	3000K-6500K	AC100-277V	>0.95	IP66	1
SR-FGB180W	180W	922*360*144mm	SMD3030	140LM	3000K-6500K	AC100-277V	>0.95	IP66	1
SR-FGB200W	200W	922*360*144mm	SMD3030	140LM	3000K-6500K	AC100-277V	>0.95	IP66	1
SR-FGB240W	240W	922*360*144mm	SMD3030	140LM	3000K-6500K	AC100-277V	>0.95	IP66	1



LED STREET LAMP SERIES

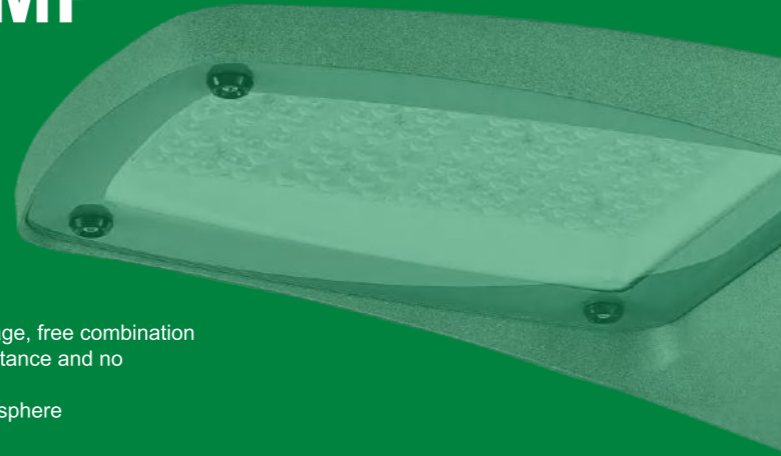

Features

1. A splicing LED projection lamp, Can be spliced with different wattage, free combination
2. All-aluminum die-cast shell, good heat dissipation, corrosion resistance and no resistance Multiple seals, outdoor waterproof and rustproof
3. Stereo light, large irradiation range, bright light effect, stylish atmosphere

LED STREET LAMP SERIES

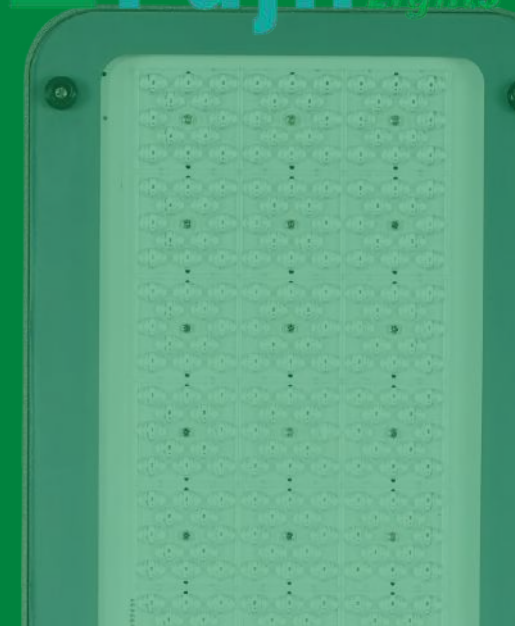
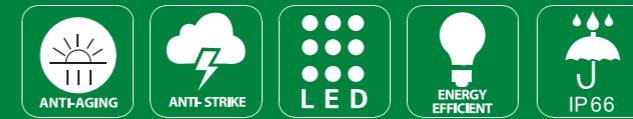

Features

1. A splicing LED projection lamp, Can be spliced with different wattage, free combination
2. All-aluminum die-cast shell, good heat dissipation, corrosion resistance and no resistance Multiple seals, outdoor waterproof and rustproof
3. Stereo light, large irradiation range, bright light effect, stylish atmosphere

SR-STV



Model No	Watts	Size	Lamp beads	Light effect	Color temperature	Voltage	Power Factor	Waterproof level	Pcs
SR-STV30W	30W	420*180*100mm	SMD3030/5050	130LM	3000K-6500K	AC100-277V	≥0.95	IP66	1
SR-STV50W	50W	470*180*110mm	SMD3030/5050	130LM	3000K-6500K	AC100-277V	≥0.95	IP66	1
SR-STV100W	100W	560*240*115mm	SMD3030/5050	130LM	3000K-6500K	AC100-277V	≥0.95	IP66	1
SR-STV150W	150W	690*280*130mm	SMD3030/5050	130LM	3000K-6500K	AC100-277V	≥0.95	IP66	1
SR-STV200W	200W	740*280*130mm	SMD3030/5050	130LM	3000K-6500K	AC100-277V	≥0.95	IP66	1



SR-STL



Model No	Watts	Size	Lamp beads	Light effect	Color temperature	Voltage	Power Factor	Waterproof level	Pcs
SR-STL30W	30W	330*150*65mm	SMD3030/5050	130LM	3000K-6500K	AC100-277V	≥0.95	IP66	1
SR-STL50W	50W	375*150*65mm	SMD3030/5050	130LM	3000K-6500K	AC100-277V	≥0.95	IP66	1
SR-STL100W	100W	525*180*65mm	SMD3030/5050	130LM	3000K-6500K	AC100-277V	≥0.95	IP66	1
SR-STL150W	150W	650*260*95mm	SMD3030/5050	130LM	3000K-6500K	AC100-277V	≥0.95	IP66	1
SR-STL200W	200W	700*260*95mm	SMD3030/5050	130LM	3000K-6500K	AC100-277V	≥0.95	IP66	1



LED STREET LAMP SERIES



Features

- 1、 A splicing LED projection lamp, Can be spliced with different wattage, free combination
- 2、 All-aluminum die-cast shell, good heat dissipation, corrosion resistance and no resistance Multiple seals,outdoor waterproof and rustproof
- 3、 Stereo light, large irradiation range, bright light effect, stylish atmosphere



SR-SYZ



Model No	Watts	Size	Lamp beads	Light effect	Color temperature	Voltage	Power Factor	Waterproof level	Pcs
SR-SYZ50W	50W	510*210*110mm	SMD3030	140LM	3000K-6500K	AC100-277V	>0.9	IP66	10
SR-SYZ100W	100W	580*265*110mm	SMD3030	140LM	3000K-6500K	AC100-277V	>0.9	IP66	10
SR-SYZ150W	150W	685*265*110mm	SMD3030	140LM	3000K-6500K	AC100-277V	>0.9	IP66	10
SR-SYZ200W	200W	735*280*110mm	SMD3030	140LM	3000K-6500K	AC100-277V	>0.9	IP66	5



LED STREET LAMP SERIES

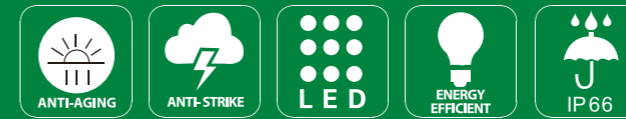

Features

- 1、 A splicing LED projection lamp, Can be spliced with different wattage, free combination
- 2、 All-aluminum die-cast shell, good heat dissipation, corrosion resistance and no resistance Multiple seals,outdoor waterproof and rustproof
- 3、 Stereo light, large irradiation range, bright light effect, stylish atmosphere

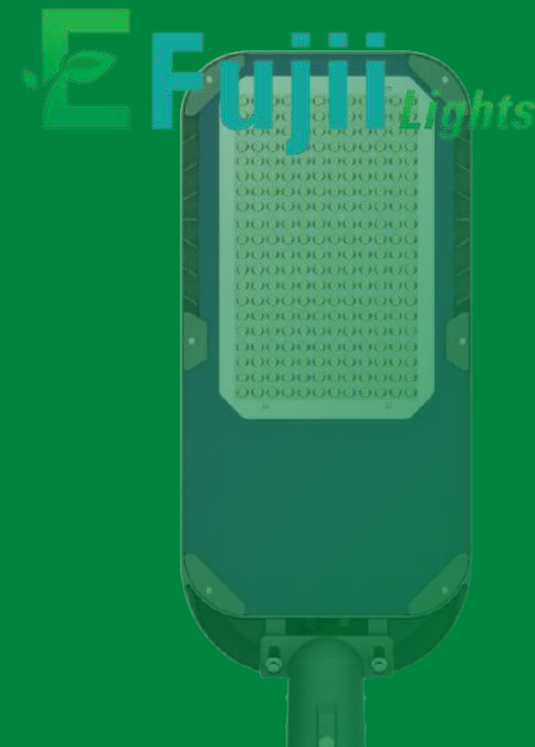

SR-STO



Model No	Watts	Size	Lamp beads	Light effect	Color temperature	Voltage	Power Factor	Waterproof level	Pcs
SR-STO50W	50W	500*200*90mm	SMD3030	130-135LM	3000K-6500K	AC100-277V	>0.95	IP66	1
SR-STO100W	100W	570*220*90mm	SMD3030	130-135LM	3000K-6500K	AC100-277V	>0.95	IP66	1
SR-STO150W	150W	640*240*90mm	SMD3030	130-135LM	3000K-6500K	AC100-277V	>0.95	IP66	1
SR-STO200W	200W	670*295*90mm	SMD3030	130-135LM	3000K-6500K	AC100-277V	>0.95	IP66	1



LED STREET LAMP SERIES



Features

1. A splicing LED projection lamp, Can be spliced with different wattage, free combination
2. All-aluminum die-cast shell, good heat dissipation, corrosion resistance and no resistance Multiple seals, outdoor waterproof and rustproof
3. Stereo light, large irradiation range, bright light effect, stylish atmosphere

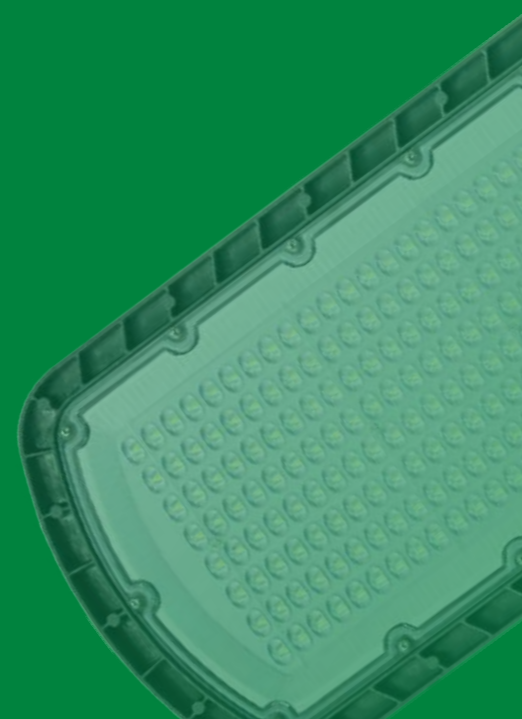

SR-STF



Model No	Watts	Size	Lamp beads	Light effect	Color temperature	Voltage	Power Factor	Waterproof level	Pcs
SR-STF50W	50W	415x170x70mm	SMD3030	120LM	3000K-6500K	AC85-265V	>0.9	IP66	10
SR-STF100W	100W	495x190x70mm	SMD3030	120LM	3000K-6500K	AC85-265V	>0.9	IP66	10
SR-STF150W	150W	595x210x80mm	SMD3030	120LM	3000K-6500K	AC85-265V	>0.9	IP66	5
SR-STF200W	200W	645x230x80mm	SMD3030	120LM	3000K-6500K	AC85-265V	>0.9	IP66	5



LED STREET LAMP SERIES

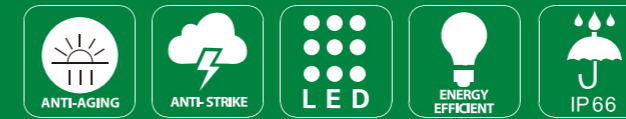

Features

1. A splicing LED projection lamp, Can be spliced with different wattage, free combination
2. All-aluminum die-cast shell, good heat dissipation, corrosion resistance and no resistance Multiple seals, outdoor waterproof and rustproof
3. Stereo light, large irradiation range, bright light effect, stylish atmosphere



SR-GST



Model No	Watts	Size	Lamp beads	Light effect	Color temperature	Voltage	Power Factor	Waterproof level	Pcs
SR-GST50W	50W	555*350*135mm	SMD3030	170LM	3000K-6500K	AC100-277V	>0.9	IP66	1
SR-GST100W	100W	638*350*135mm	SMD3030	170LM	3000K-6500K	AC100-277V	>0.9	IP66	1
SR-GST150W	150W	721*350*135mm	SMD3030	170LM	3000K-6500K	AC100-277V	>0.9	IP66	1
SR-GST200W	200W	804*350*135mm	SMD3030	170LM	3000K-6500K	AC100-277V	>0.9	IP66	1
SR-GST250W	250W	887*350*135mm	SMD3030	170LM	3000K-6500K	AC100-277V	>0.9	IP66	1
SR-GST300W	300W	970*350*135mm	SMD3030	170LM	3000K-6500K	AC100-277V	>0.9	IP66	1



LED STREET LAMP SERIES



Features

1. A splicing LED projection lamp, Can be spliced with different wattage, free combination
2. All-aluminum die-cast shell, good heat dissipation, corrosion resistance and no resistance Multiple seals, outdoor waterproof and rustproof
3. Stereo light, large irradiation range, bright light effect, stylish atmosphere



SR-FGA



Model No	Watts	Size	Lamp beads	Light effect	Color temperature	Voltage	Power Factor	Waterproof level	Pcs
SR-FGA50W	50W	577*232.6*103.2mm	SMD3030	140LM	3000K-6500K	AC100-277V	>0.95	IP66	1
SR-FGA60W	60W	577*232.6*103.2mm	SMD3030	140LM	3000K-6500K	AC100-277V	>0.95	IP66	1
SR-FGA80W	80W	627*271.5*103.2mm	SMD3030	140LM	3000K-6500K	AC100-277V	>0.95	IP66	1
SR-FGA100W	100W	627*271.5*103.2mm	SMD3030	140LM	3000K-6500K	AC100-277V	>0.95	IP66	1
SR-FGA120W	120W	627*271.5*103.2mm	SMD3030	140LM	3000K-6500K	AC100-277V	>0.95	IP66	1
SR-FGA150W	150W	768*301*103.5mm	SMD3030	140LM	3000K-6500K	AC100-277V	>0.95	IP66	1
SR-FGA200W	200W	768*301*103.5mm	SMD3030	140LM	3000K-6500K	AC100-277V	>0.95	IP66	1
SR-FGA240W	240W	768*301*103.5mm	SMD3030	140LM	3000K-6500K	AC100-277V	>0.95	IP66	1



LED STREET LAMP SERIES

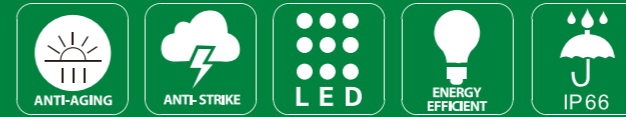

Features

1. A splicing LED projection lamp, Can be spliced with different wattage, free combination
2. All-aluminum die-cast shell, good heat dissipation, corrosion resistance and no resistance Multiple seals, outdoor waterproof and rustproof
3. Stereo light, large irradiation range, bright light effect, stylish atmosphere



SR-LSCL



Model No	Watts	Size	Lamp beads	Light effect	Color temperature	Voltage	Power Factor	Waterproof level	Pcs
SR-LSCL50W	50W	362*145*62mm	SMD2835	120LM	3000K-6500K	AC85-265V AC110/240V	>0.9	IP66	10
SR-LSCL100W	100W	486*165*62mm	SMD2835	120LM	3000K-6500K	AC85-265V AC110/240V	>0.9	IP66	10
SR-LSCL150W	150W	545*206*72mm	SMD2835	120LM	3000K-6500K	AC85-265V AC110/240V	>0.9	IP66	10
SR-LSCL200W	200W	623*235*72mm	SMD2835	120LM	3000K-6500K	AC85-265V AC110/240V	>0.9	IP66	5



LED STREET LAMP SERIES



Features

1. A splicing LED projection lamp, Can be spliced with different wattage, free combination
2. All-aluminum die-cast shell, good heat dissipation, corrosion resistance and no resistance Multiple seals, outdoor waterproof and rustproof
3. Stereo light, large irradiation range, bright light effect, stylish atmosphere

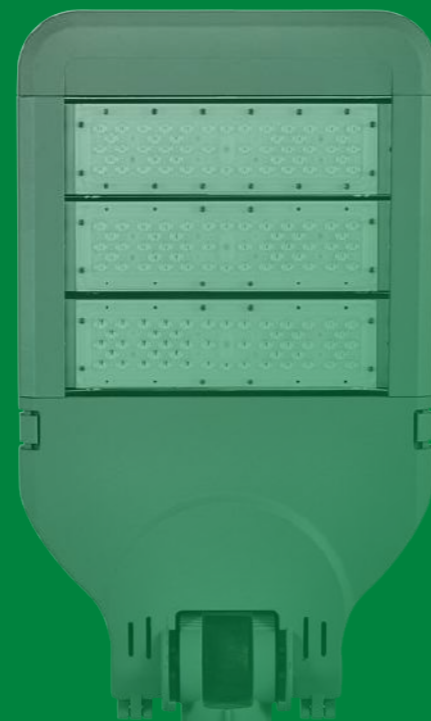

SR-GSL



Model No	Watts	Size	Lamp beads	Light effect	Color temperature	Voltage	Power Factor	Waterproof level	Pcs
SR-GSL50W	50W	530*350*90mm	SMD3030	150LM	3000K-6500K	AC100-277V	>0.95	IP66	1
SR-GSL100W	100W	610*350*90mm	SMD3030	150LM	3000K-6500K	AC100-277V	>0.95	IP66	1
SR-GSL150W	150W	690*350*90mm	SMD3030	150LM	3000K-6500K	AC100-277V	>0.95	IP66	1
SR-GSL200W	200W	770*350*90mm	SMD3030	150LM	3000K-6500K	AC100-277V	>0.95	IP66	1
SR-GSL250W	250W	850*350*90mm	SMD3030	150LM	3000K-6500K	AC100-277V	>0.95	IP66	1



LED STREET LAMP SERIES

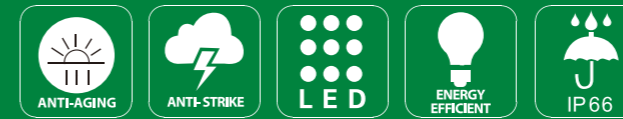

Features

1. A splicing LED projection lamp, Can be spliced with different wattage, free combination
2. All-aluminum die-cast shell, good heat dissipation, corrosion resistance and no resistance Multiple seals, outdoor waterproof and rustproof
3. Stereo light, large irradiation range, bright light effect, stylish atmosphere



SR-STJ



Model No	Watts	Size	Lamp beads	Light effect	Color temperature	Voltage	Power Factor	Waterproof level	Pcs
SR-STJ	20W-80W	578*228*135mm	SMD3030	150LM	3000K-6500K	AC100-277V	>0.95	IP66	1
SR-STJ	80W-150W	599*256*141mm	SMD3030	150LM	3000K-6500K	AC100-277V	>0.95	IP66	1
SR-STJ	150W-240W	729*328*157mm	SMD3030	150LM	3000K-6500K	AC100-277V	>0.95	IP66	1



LED STREET LAMP SERIES



Features

1. A splicing LED projection lamp, Can be spliced with different wattage, free combination
2. All-aluminum die-cast shell, good heat dissipation, corrosion resistance and no resistance Multiple seals, outdoor waterproof and rustproof
3. Stereo light, large irradiation range, bright light effect, stylish atmosphere



LED STREET LAMP SERIES

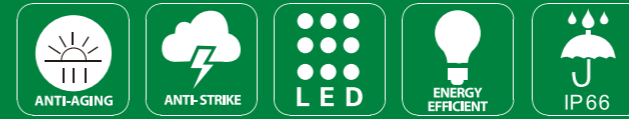

Features

1. A splicing LED projection lamp, Can be spliced with different wattage, free combination
2. All-aluminum die-cast shell, good heat dissipation, corrosion resistance and no resistance Multiple seals, outdoor waterproof and rustproof
3. Stereo light, large irradiation range, bright light effect, stylish atmosphere



SR-STD



Model No	Watts	Size	Lamp beads	Light effect	Color temperature	Voltage	Power Factor	Waterproof level	Pcs
SR-STD30W	30W	380*172*65mm	SMD2835	120LM	3000K-6500K	AC85-265V	>0.9	IP66	20
SR-STD50W	50W	420*200*70mm	SMD2835	120LM	3000K-6500K	AC85-265V	>0.9	IP66	10
SR-STD100W	100W	495*215*80mm	SMD2835	120LM	3000K-6500K	AC85-265V	>0.9	IP66	10
SR-STD150W	150W	540*215*80mm	SMD2835	120LM	3000K-6500K	AC85-265V	>0.9	IP66	5
SR-STD200W	200W	600*235*80mm	SMD2835	120LM	3000K-6500K	AC85-265V	>0.9	IP66	5



SR-STY



Model No	Watts	Size	Lamp beads	Light effect	Color temperature	Voltage	Power Factor	Waterproof level	Pcs
SR-STY50W	50W	500x170*75mm	SMD3030	120-130LM	3000K-6500K	AC100-265V	≥0.95	IP66	1
SR-STY100W	100W	650x200x80mm	SMD3030	120-130LM	3000K-6500K	AC100-265V	≥0.95	IP66	1
SR-STY150W	150W	680x220x85mm	SMD3030	120-130LM	3000K-6500K	AC100-265V	≥0.95	IP66	1
SR-STY200W	200W	778*251*96.5mm	SMD3030	120-130LM	3000K-6500K	AC100-265V	≥0.95	IP66	1



LED STREET LAMP SERIES



Features

1. A splicing LED projection lamp, Can be spliced with different wattage, free combination
2. All-aluminum die-cast shell, good heat dissipation, corrosion resistance and no resistance Multiple seals, outdoor waterproof and rustproof
3. Stereo light, large irradiation range, bright light effect, stylish atmosphere

SR-STA



Model No	Watts	Size	Lamp beads	Light effect	Color temperature	Voltage	Power Factor	Waterproof level	Pcs
SR-STA50W	50W	425*200*121mm	SMD3030	130LM	3000K-6500K	AC100-277V	>0.95	IP66	1
SR-STA100W	100W	540*256*125mm	SMD3030	130LM	3000K-6500K	AC100-277V	>0.95	IP66	1
SR-STA150W	150W	598*256*125mm	SMD3030	130LM	3000K-6500K	AC100-277V	>0.95	IP66	1



LED STREET LAMP SERIES

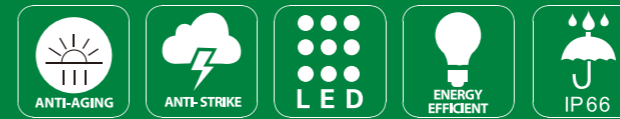

Features

1. A splicing LED projection lamp, Can be spliced with different wattage, free combination
2. All-aluminum die-cast shell, good heat dissipation, corrosion resistance and no resistance Multiple seals, outdoor waterproof and rustproof
3. Stereo light, large irradiation range, bright light effect, stylish atmosphere

SR-STC



Model No	Watts	Size	Lamp beads	Light effect	Color temperature	Voltage	Power Factor	Waterproof level	Pcs
SR-STC100W	100W	542*316*65mm	SMD3030	150LM	3000K-6500K	AC100-277V	>0.95	IP66	1
SR-STC200W	200W	663*316*65mm	SMD3030	150LM	3000K-6500K	AC100-277V	>0.95	IP66	1
SR-STC300W	300W	785*316*75mm	SMD3030	150LM	3000K-6500K	AC100-277V	>0.95	IP66	1



LED FLOOD LIGHT SERIES



Features

- 1、 Multiple seals, outdoor waterproof and dustproof
- 2、 Tempered glass mask with high light transmittance and strong impact resistance
- 3、 Adjustable mounting bracket to meet the needs of different angles
- 4、 All-aluminum die-cast shell, good heat dissipation, corrosion resistance and no rust



SR-FLE



Model No	Watts	Size	Lamp beads	Light effect	Color temperature	Voltage	Power Factor	Waterproof level	Pcs
SR-FLE50W	50W	320*239*53mm	SMD3030	140LM	3000K-6500K	AC100-277V	>0.95	IP66	1
SR-FLE80W	80W	364.5*264*58mm	SMD3030	140LM	3000K-6500K	AC100-277V	>0.95	IP66	1
SR-FLE100W	100W	412.9*315*63mm	SMD3030	140LM	3000K-6500K	AC100-277V	>0.95	IP66	1
SR-FLE150W	150W	439.9*348.9*63mm	SMD3030	140LM	3000K-6500K	AC100-277V	>0.95	IP66	1
SR-FLE200W	200W	480*378.9*63mm	SMD3030	140LM	3000K-6500K	AC100-277V	>0.95	IP66	1



LED FLOOD LIGHT SERIES

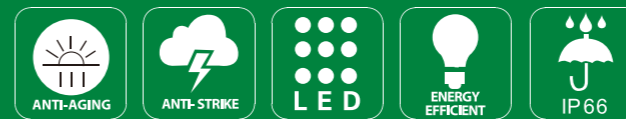

Features

- 1、 Multiple seals, outdoor waterproof and dustproof
- 2、 Tempered glass mask with high light transmittance and strong impact resistance
- 3、 Adjustable mounting bracket to meet the needs of different angles
- 4、 All-aluminum die-cast shell, good heat dissipation, corrosion resistance and no rust

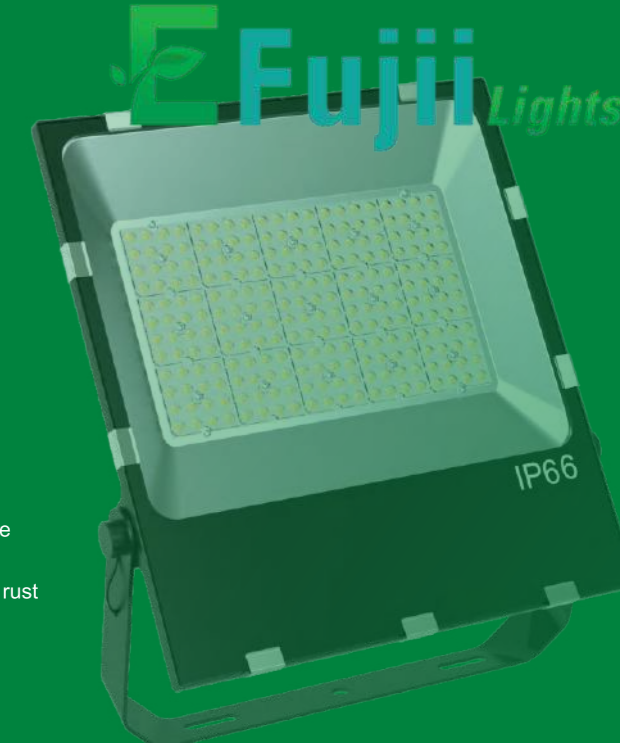

SR-FLX



Model No	Watts	Size	Lamp beads	Light effect	Color temperature	Voltage	Power Factor	Waterproof level	Pcs
SR-FLX50W	50W	310.5*220*50mm	SMD3030	140LM	3000K-6500K	AC100-277V	>0.95	IP66	1
SR-FLX80W	80W	354.5*245*55mm	SMD3030	140LM	3000K-6500K	AC100-277V	>0.95	IP66	1
SR-FLX100W	100W	402.5*295*60mm	SMD3030	140LM	3000K-6500K	AC100-277V	>0.95	IP66	1
SR-FLX150W	150W	430.5*360*60mm	SMD3030	140LM	3000K-6500K	AC100-277V	>0.95	IP66	1
SR-FLX200W	200W	470.5*330*60mm	SMD3030	140LM	3000K-6500K	AC100-277V	>0.95	IP66	1
SR-FLX300W	300W	565*360*60mm	SMD3030	140LM	3000K-6500K	AC100-277V	>0.95	IP66	1
SR-FLX400W	400W	585*457*65mm	SMD3030	140LM	3000K-6500K	AC100-277V	>0.95	IP66	1



LED FLOOD LIGHT SERIES



Features

1. Multiple seals, outdoor waterproof and dustproof
2. Tempered glass mask with high light transmittance and strong impact resistance
3. Adjustable mounting bracket to meet the needs of different angles
4. All-aluminum die-cast shell, good heat dissipation, corrosion resistance and no rust

SR-FLH



Model No	Watts	Size	Lamp beads	Light effect	Color temperature	Voltage	Power Factor	Waterproof level	Pcs
SR-FLH50W	50W	217*313*51mm	SMD3030	140LM	3000K-6500K	AC100-277V	>0.95	IP66	1
SR-FLH100W	100W	343*369*56mm	SMD3030	140LM	3000K-6500K	AC100-277V	>0.95	IP66	1
SR-FLH150W	150W	368*412*58mm	SMD3030	140LM	3000K-6500K	AC100-277V	>0.95	IP66	1
SR-FLH200W	200W	393*422*58mm	SMD3030	140LM	3000K-6500K	AC100-277V	>0.95	IP66	1
SR-FLH300W	300W	483*439*67mm	SMD3030	140LM	3000K-6500K	AC100-277V	>0.95	IP66	1



LED FLOOD LIGHT SERIES

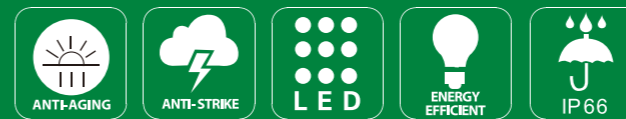

Features

1. Multiple seals, outdoor waterproof and dustproof
2. Tempered glass mask with high light transmittance and strong impact resistance
3. Adjustable mounting bracket to meet the needs of different angles
4. All-aluminum die-cast shell, good heat dissipation, corrosion resistance and no rust

SR-FLB



Model No	Watts	Size	Lamp beads	Light effect	Color temperature	Voltage	Power Factor	Waterproof level	Pcs
SR-FLB100W	100W	263*263*45mm	SMD3030	140LM	3000K-6500K	AC100-277V	>0.95	IP66	1
SR-FLB150W	150W	314*314*45mm	SMD3030	140LM	3000K-6500K	AC100-277V	>0.95	IP66	1
SR-FLB200W	200W	314*314*45mm	SMD3030	140LM	3000K-6500K	AC100-277V	>0.95	IP66	1



LED FLOOD LIGHT SERIES



Features

- 1、 Multiple seals, outdoor waterproof and dustproof
- 2、 Tempered glass mask with high light transmittance and strong impact resistance
- 3、 Adjustable mounting bracket to meet the needs of different angles
- 4、 All-aluminum die-cast shell, good heat dissipation, corrosion resistance and no rust

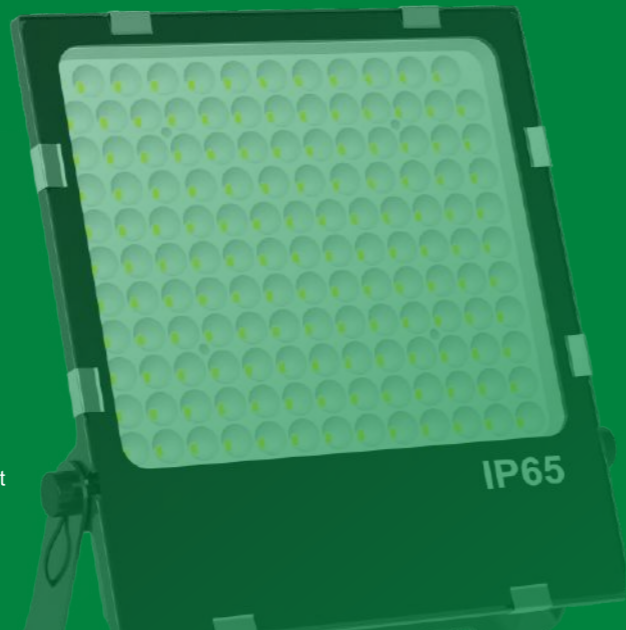

LED FLOOD LIGHT SERIES

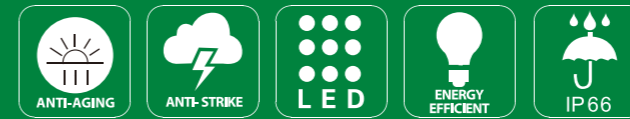

Features

- 1、 Multiple seals, outdoor waterproof and dustproof
- 2、 Tempered glass mask with high light transmittance and strong impact resistance
- 3、 Adjustable mounting bracket to meet the needs of different angles
- 4、 All-aluminum die-cast shell, good heat dissipation, corrosion resistance and no rust

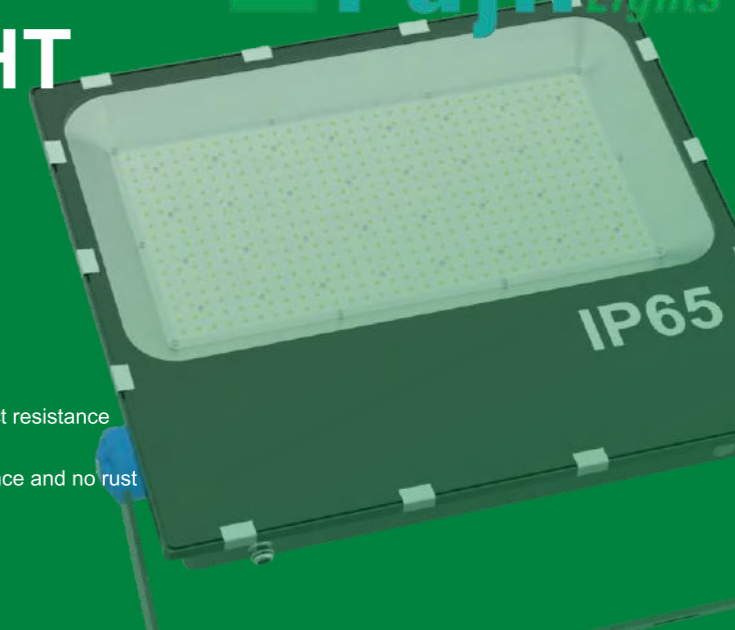

SR-FLJ



Model No	Watts	Size	Lamp beads	Light effect	Color temperature	Voltage	Power Factor	Waterproof level	Pcs
SR-FLJ50W	50W	310.5*220*50mm	SMD3030	140LM	3000K-6500K	AC100-277V	>0.95	IP66	1
SR-FLJ80W	80W	354.5*245*55mm	SMD3030	140LM	3000K-6500K	AC100-277V	>0.95	IP66	1
SR-FLJ100W	100W	402.5*295*60mm	SMD3030	140LM	3000K-6500K	AC100-277V	>0.95	IP66	1
SR-FLJ150W	150W	430.5*330*60mm	SMD3030	140LM	3000K-6500K	AC100-277V	>0.95	IP66	1
SR-FLJ200W	200W	470.5*360*60mm	SMD3030	140LM	3000K-6500K	AC100-277V	>0.95	IP66	1



SR-FLP

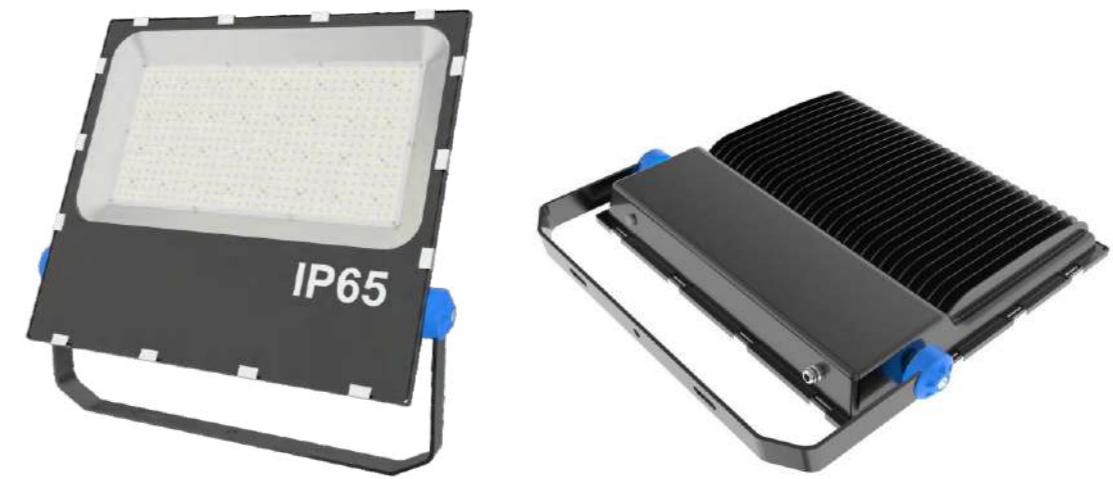

Model No	Watts	Size	Lamp beads	Light effect	Color temperature	Voltage	Power Factor	Waterproof level	Pcs
SR-FLP50W	50W	310.5*220*50mm	SMD3030	140LM	3000K-6500K	AC100-277V	>0.95	IP66	1
SR-FLP80W	80W	354.5*245*55mm	SMD3030	140LM	3000K-6500K	AC100-277V	>0.95	IP66	1
SR-FLP100W	100W	402.5*295*60mm	SMD3030	140LM	3000K-6500K	AC100-277V	>0.95	IP66	1
SR-FLP150W	150W	430.5*330*60mm	SMD3030	140LM	3000K-6500K	AC100-277V	>0.95	IP66	1
SR-FLP200W	200W	470.5*360*60mm	SMD3030	140LM	3000K-6500K	AC100-277V	>0.95	IP66	1
SR-FLP300W	300W	565.0*457*65mm	SMD3030	140LM	3000K-6500K	AC100-277V	>0.95	IP66	1
SR-FLP400W	400W	585.0*559*70mm	SMD3030	140LM	3000K-6500K	AC100-277V	>0.95	IP66	1



LED FLOOD LIGHT SERIES



Features

- 1、 Multiple seals, outdoor waterproof and dustproof
- 2、 Tempered glass mask with high light transmittance and strong impact resistance
- 3、 Adjustable mounting bracket to meet the needs of different angles
- 4、 All-aluminum die-cast shell, good heat dissipation, corrosion resistance and no rust



SR-FLL



Model No	Watts	Size	Lamp beads	Light effect	Color temperature	Voltage	Power Factor	Waterproof level	Pcs
SR-FLL100W	100W	378*426*75mm	SMD3030	150LM	3000K-6500K	AC100-277V	>0.95	IP66	1
SR-FLL150W	150W	378*426*75mm	SMD3030	150LM	3000K-6500K	AC100-277V	>0.95	IP66	1
SR-FLL200W	200W	378*546*75mm	SMD3030	150LM	3000K-6500K	AC100-277V	>0.95	IP66	1
SR-FLL240W	240W	378*546*75mm	SMD3030	150LM	3000K-6500K	AC100-277V	>0.95	IP66	1
SR-FLL300W	300W	378*670.5*84mm	SMD3030	150LM	3000K-6500K	AC100-277V	>0.95	IP66	1
SR-FLL320W	320W	378*670.5*84mm	SMD3030	150LM	3000K-6500K	AC100-277V	>0.95	IP66	1



LED FLOOD LIGHT SERIES

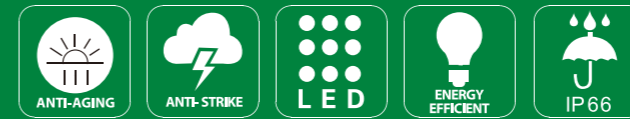

Features

- 1、 Multiple seals, outdoor waterproof and dustproof
- 2、 Tempered glass mask with high light transmittance and strong impact resistance
- 3、 Adjustable mounting bracket to meet the needs of different angles
- 4、 All-aluminum die-cast shell, good heat dissipation, corrosion resistance and no rust

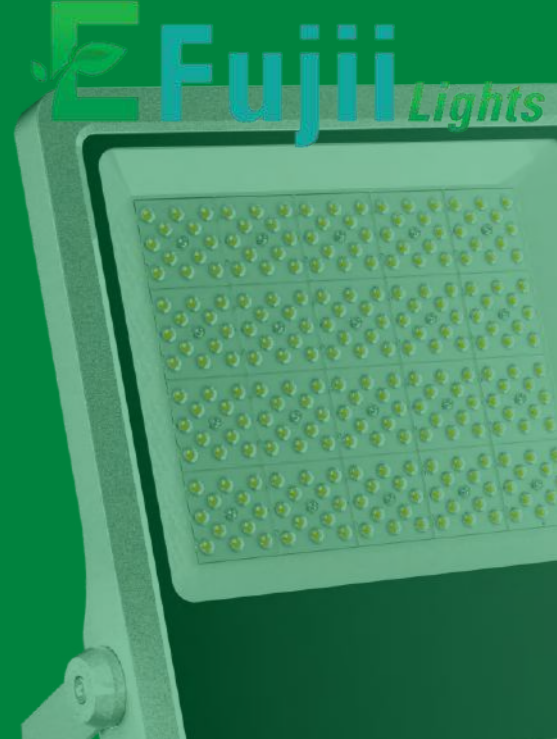

SR-FLR



Model No	Watts	Size	Lamp beads	Light effect	Color temperature	Voltage	Power Factor	Waterproof level	Pcs
SR-FLR50W	50W	263*224*45mm	SMD2835	140LM	3000K-6500K	AC100-277V	>0.95	IP66	1
SR-FLR100W	100W	315*269*50mm	SMD2835	140LM	3000K-6500K	AC100-277V	>0.95	IP66	1
SR-FLR150W	150W	370*322*56mm	SMD2835	140LM	3000K-6500K	AC100-277V	>0.95	IP66	1
SR-FLR200W	200W	416*352*58mm	SMD2835	140LM	3000K-6500K	AC100-277V	>0.95	IP66	1
SR-FLR300W	300W	481*408*60mm	SMD2835	140LM	3000K-6500K	AC100-277V	>0.95	IP66	1
SR-FLR400W	400W	490*520*65mm	SMD2835	140LM	3000K-6500K	AC100-277V	>0.95	IP66	1



LED FLOOD LIGHT SERIES



Features

- 1、 Multiple seals, outdoor waterproof and dustproof
- 2、 Tempered glass mask with high light transmittance and strong impact resistance
- 3、 Adjustable mounting bracket to meet the needs of different angles
- 4、 All-aluminum die-cast shell, good heat dissipation, corrosion resistance and no rust



SR-FLY

LED FLOOD LIGHT SERIES

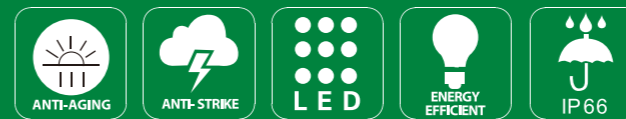

Features

- 1、 Multiple seals, outdoor waterproof and dustproof
- 2、 Tempered glass mask with high light transmittance and strong impact resistance
- 3、 Adjustable mounting bracket to meet the needs of different angles
- 4、 All-aluminum die-cast shell, good heat dissipation, corrosion resistance and no rust

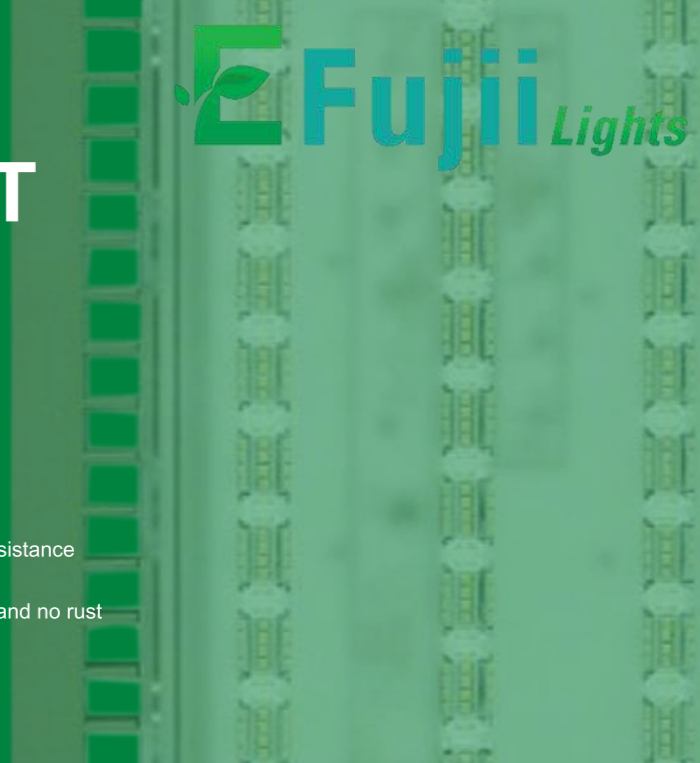

SR-FLP



Model No	Watts	Size	Lamp beads	Light effect	Color temperature	Voltage	Power Factor	Waterproof level	Pcs
SR-FLY30W	30W	210*160*35mm	SMD2835/SMD3030	120LM	3000K-6500K	AC110/240V	≥0.9	IP66	15
SR-FLY50W	50W	235*175*35mm	SMD2835/SMD3030	120LM	3000K-6500K	AC110/240V	≥0.9	IP66	15
SR-FLY100W	100W	295*210*45mm	SMD2835/SMD3030	120LM	3000K-6500K	AC110/240V	≥0.9	IP66	10

Model No	Watts	Size	Lamp beads	Light effect	Color temperature	Voltage	Power Factor	Waterproof level	Pcs
SR-FLP30W	30W	195*145*50mm	SMD2835/SMD3030	120LM	3000K-6500K	AC110/240V	≥0.9	IP66	20
SR-FLP50W	50W	270*203*50mm	SMD2835/SMD3030	120LM	3000K-6500K	AC110/240V	≥0.9	IP66	10
SR-FLP100W	100W	315*235*50mm	SMD2835/SMD3030	120LM	3000K-6500K	AC110/240V	≥0.9	IP66	10



LED FLOOD LIGHT SERIES



Features

- 1、Splicing LED projector, can splice different wattage, free combination of all aluminum die-casting shell, good heat dissipation, corrosion resistance, no corrosion, multiple sealing, outdoor waterproof and dustproof
- 2、A variety of specifications to meet individual needs



LED FLOOD LIGHT SERIES

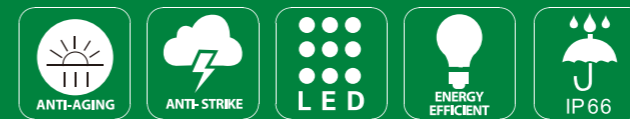

Features

- 1、Multiple seals, outdoor waterproof and dustproof
- 2、Tempered glass mask with high light transmittance and strong impact resistance
- 3、Adjustable mounting bracket to meet the needs of different angles
- 4、All-aluminum die-cast shell, good heat dissipation, corrosion resistance and no rust

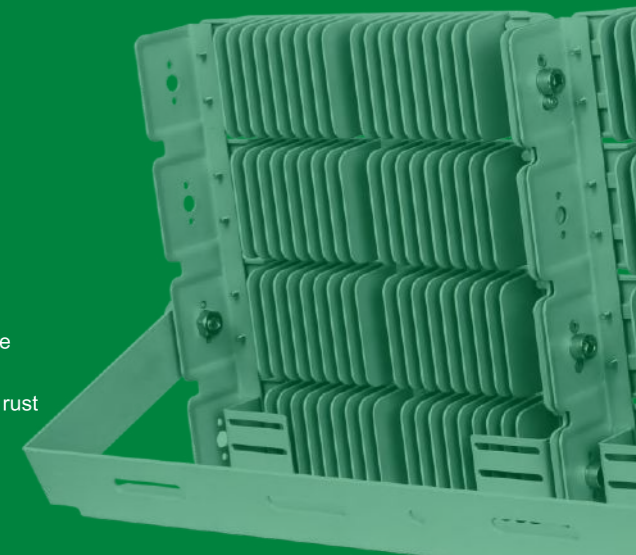

SR-FLQ

SR-FLF



Model No	Watts	Size	Lamp beads	Light effect	Color temperature	Voltage	Power Factor	Waterproof level	Pcs
SR-FLQ50W	50W	265*42*140mm	SMD2835/SMD3030	120LM	3000K-6500K	AC85-265V AC110/240V	≥0.9	IP66	20
SR-FLQ100W	100W	275*47*260mm	SMD2835/SMD3030	120LM	3000K-6500K	AC85-265V AC110/240V	≥0.9	IP66	10
SR-FLQ150W	150W	380*47*280mm	SMD2835/SMD3030	120LM	3000K-6500K	AC85-265V AC110/240V	≥0.9	IP66	1
SR-FLQ200W	200W	520*47*265mm	SMD2835/SMD3030	120LM	3000K-6500K	AC85-265V AC110/240V	≥0.9	IP66	1
SR-FLQ300W	300W	520*170*380mm	SMD2835/SMD3030	120LM	3000K-6500K	AC85-265V AC110/240V	≥0.9	IP66	1

Model No	Watts	Size	Lamp beads	Light effect	Color temperature	Voltage	Power Factor	Waterproof level	Pcs
SR-FLF50W	50W	75*305*140mm	SMD3030	150LM	3000K-6500K	AC100-277V	>0.95	IP66	1
SR-FLF100W	100W	160*305*140mm	SMD3030	150LM	3000K-6500K	AC100-277V	>0.95	IP66	1
SR-FLF150W	150W	245*305*140mm	SMD3030	150LM	3000K-6500K	AC100-277V	>0.95	IP66	1
SR-FLF200W	200W	330*305*140mm	SMD3030	150LM	3000K-6500K	AC100-277V	>0.95	IP66	1
SR-FLF250W	250W	415*305*140mm	SMD3030	150LM	3000K-6500K	AC100-277V	>0.95	IP66	1
SR-FLF300W	300W	500*305*140mm	SMD3030	150LM	3000K-6500K	AC100-277V	>0.95	IP66	1



LED FLOOD LIGHT SERIES



Features

- 1、 Multiple seals, outdoor waterproof and dustproof
- 2、 Tempered glass mask with high light transmittance and strong impact resistance
- 3、 Adjustable mounting bracket to meet the needs of different angles
- 4、 All-aluminum die-cast shell, good heat dissipation, corrosion resistance and no rust

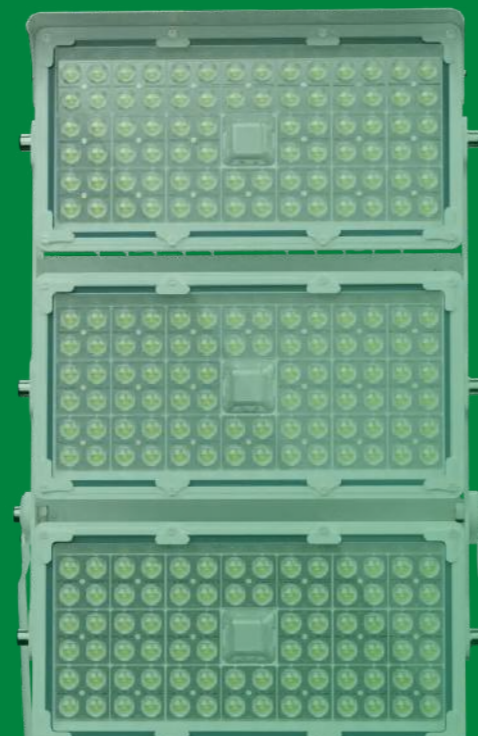

SR-FCP



Model No	Watts	Size	Lamp beads	Light effect	Color temperature	Voltage	Power Factor	Waterproof level	Pcs
SR-FCP200W	200W	442*290*121mm	SMD3030/5050	170-190LM	3000K-6500K	AC100-277V	>0.95	IP66	1
SR-FCP250W	250W	442*290*121mm	SMD3030/5050	170-190LM	3000K-6500K	AC100-277V	>0.95	IP66	1
SR-FCP400W	400W	522*441*121mm	SMD3030/5050	170-190LM	3000K-6500K	AC100-277V	>0.95	IP66	1
SR-FCP500W	500W	522*441*121mm	SMD3030/5050	170-190LM	3000K-6500K	AC100-277V	>0.95	IP66	1
SR-FCP600W	600W	754*441*121mm	SMD3030/5050	170-190LM	3000K-6500K	AC100-277V	>0.95	IP66	1
SR-FCP750W	750W	754*441*121mm	SMD3030/5050	170-190LM	3000K-6500K	AC100-277V	>0.95	IP66	1
SR-FCP800W	800W	845*547*129.5mm	SMD3030/5050	170-190LM	3000K-6500K	AC100-277V	>0.95	IP66	1
SR-FCP1000W	1000W	845*547*129.5mm	SMD3030/5050	170-190LM	3000K-6500K	AC100-277V	>0.95	IP66	1
SR-FCP1200W	1200W	845*765*129.5mm	SMD3030/5050	170-190LM	3000K-6500K	AC100-277V	>0.95	IP66	1
SR-FCP1500W	1500W	845*765*129.5mm	SMD3030/5050	170-190LM	3000K-6500K	AC100-277V	>0.95	IP66	1



LED FLOOD LIGHT SERIES

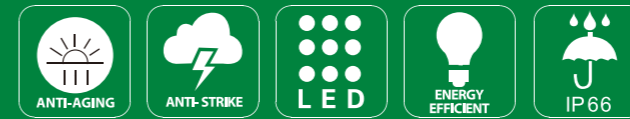

Features

- 1、 Multiple seals, outdoor waterproof and dustproof
- 2、 Tempered glass mask with high light transmittance and strong impact resistance
- 3、 Adjustable mounting bracket to meet the needs of different angles
- 4、 All-aluminum die-cast shell, good heat dissipation, corrosion resistance and no rust



SR-FLP



Model No	Watts	Size	Lamp beads	Light effect	Color temperature	Voltage	Power Factor	Waterproof level	Pcs
SR-FLP-50W	50W	258*183*50mm	SMD3030	140LM	3000K-6500K	AC100-277V	>0.95	IP66	1
SR-FLP-100W	100W	320*235*55mm	SMD3030	140LM	3000K-6500K	AC100-277V	>0.95	IP66	1
SR-FLP-200W	200W	395*290*62mm	SMD3030	140LM	3000K-6500K	AC100-277V	>0.95	IP66	1
SR-FLP-400W	400W	650*475*72mm	SMD3030	140LM	3000K-6500K	AC100-277V	>0.95	IP66	1



LED SOLAR LAMP SERIES



Features

- 1、 Multiple seals, outdoor waterproof and dustproof
- 2、 Tempered glass mask with high light transmittance and strong impact resistance
- 3、 Adjustable mounting bracket to meet the needs of different angles
- 4、 All-aluminum die-cast shell, good heat dissipation, corrosion resistance and no rust



LED SOLAR LAMP SERIES

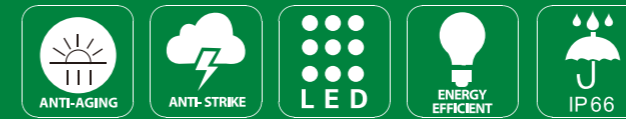

Features

- 1、 Multiple seals, outdoor waterproof and dustproof
- 2、 Tempered glass mask with high light transmittance and strong impact resistance
- 3、 Adjustable mounting bracket to meet the needs of different angles
- 4、 All-aluminum die-cast shell, good heat dissipation, corrosion resistance and no rust



SR-TW-YY



Model No	Watts	Size	Lamp beads	Light effect	Color temperature	Battery	Solar panel	Waterproof level	Pcs
SR-TW-YY-100	100W	550*288*130mm	SMD3030	130LM	2700K-7500K	3.2V 20AH	5V 25W	IP66	1
SR-TW-YY-200	200W	550*288*130mm	SMD3030	130LM	2700K-7500K	3.2V 20AH	5V 25W	IP66	1
SR-TW-YY-300	300W	657*323*130mm	SMD3030	130LM	2700K-7500K	3.2V 30AH	5V 35W	IP66	1
SR-TW-YY-400	400W	860*350*130mm	SMD3030	130LM	2700K-7500K	3.2V 45AH	5V 50W	IP66	1



SR-SLST



Model No	Watts	Size	Lamp beads	Light effect	Color temperature	Battery	Solar panel	Waterproof level	Pcs
SR-SLST300W	300W	887*400*160mm	SMD3030	130LM	2700K-7500K	12.8V 15AH	6V 32W	IP66	1
SR-SLST400W	400W	1160*400*160mm	SMD3030	130LM	2700K-7500K	12.8V 20AH	6V 40W	IP66	1
SR-SLST500W	500W	1435*400*160mm	SMD3030	130LM	2700K-7500K	12.8V 25AH	6V 45W	IP66	1



LED COURTYARD LAMP SERIES



Features

- 1、 A splicing LED projection lamp, Can be spliced with different wattage, free combination
- 2、 All-aluminum die-cast shell, good heat dissipation, corrosion resistance and no resistance Multiple seals,outdoor waterproof and rustproof
- 3、 Stereo light, large irradiation range, bright light effect, stylish atmosphere

SR-FGR



Model No	Watts	Size	Lamp beads	Light effect	Color temperature	Voltage	Power Factor	Waterproof level	Pcs
SR-FGR100W	100W	360*75*504mm	SMD3030	120LM	3000K-6500K	AC100-265V	>0.95	IP66	1
SR-FGR150W	150W	360*75*504mm	SMD3030	120LM	3000K-6500K	AC100-265V	>0.95	IP66	1



LED COURTYARD LAMP SERIES

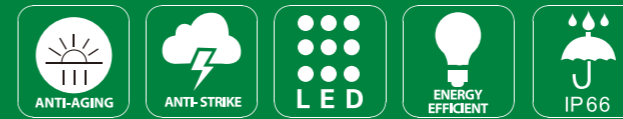

Features

- 1、 A splicing LED projection lamp, Can be spliced with different wattage, free combination
- 2、 All-aluminum die-cast shell, good heat dissipation, corrosion resistance and no resistance Multiple seals,outdoor waterproof and rustproof
- 3、 Stereo light, large irradiation range, bright light effect, stylish atmosphere

SR-FGM



Model No	Watts	Size	Lamp beads	Light effect	Color temperature	Voltage	Power Factor	Waterproof level	Pcs
SR-FGB50W	50W	423*520mm	SMD3030	120LM	3000K-6500K	AC100-265V	>0.9	IP66	1
SR-FGB100W	100W	423*520mm	SMD3030	120LM	3000K-6500K	AC100-265V	>0.9	IP66	1
SR-FGB150W	150W	423*520mm	SMD3030	120LM	3000K-6500K	AC100-265V	>0.9	IP66	1



LED COURTYARD LAMP SERIES



Features

- 1、 A splicing LED projection lamp, Can be spliced with different wattage, free combination
- 2、 All-aluminum die-cast shell, good heat dissipation, corrosion resistance and no resistance Multiple seals, outdoor waterproof and rustproof
- 3、 Stereo light, large irradiation range, bright light effect, stylish atmosphere

LED COURTYARD LAMP SERIES

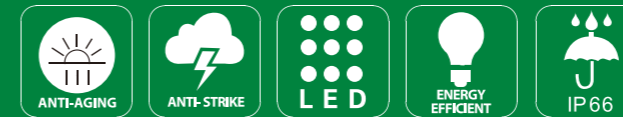

Features

- 1、 A splicing LED projection lamp, Can be spliced with different wattage, free combination
- 2、 All-aluminum die-cast shell, good heat dissipation, corrosion resistance and no resistance Multiple seals, outdoor waterproof and rustproof
- 3、 Stereo light, large irradiation range, bright light effect, stylish atmosphere

SR-FGP



Model No	Watts	Size	Lamp beads	Light effect	Color temperature	Voltage	Power Factor	Waterproof level	Pcs
SR-FGP50W	50W	290*H379mm	SMD3030	120LM	3000K-6500K	AC100-265V	>0.95	IP66	1
SR-FGP100W	100W	340*H383mm	SMD3030	120LM	3000K-6500K	AC100-265V	>0.95	IP66	1
SR-FGP150W	150W	380*H383mm	SMD3030	120LM	3000K-6500K	AC100-265V	>0.95	IP66	1



SR-FGN



Model No	Watts	Size	Lamp beads	Light effect	Color temperature	Voltage	Power Factor	Waterproof level	Pcs
SR-FGN30W	30W	560.8*490*561mm	SMD3030	130LM	3000K-6500K	AC100-277V	>0.95	IP66	1
SR-FGN50W	50W	560.8*490*561mm	SMD3030	130LM	3000K-6500K	AC100-277V	>0.95	IP66	1
SR-FGN80W	80W	560.8*490*561mm	SMD3030	130LM	3000K-6500K	AC100-277V	>0.95	IP66	1
SR-FGN100W	100W	560.8*490*561mm	SMD3030	130LM	3000K-6500K	AC100-277V	>0.95	IP66	1
SR-FGN120W	120W	560.8*490*561mm	SMD3030	130LM	3000K-6500K	AC100-277V	>0.95	IP66	1
SR-FGN150W	150W	560.8*490*561mm	SMD3030	130LM	3000K-6500K	AC100-277V	>0.95	IP66	1



LED COURTYARD LAMP SERIES



Features

- 1、 A splicing LED projection lamp, Can be spliced with different wattage, free combination
- 2、 All-aluminum die-cast shell, good heat dissipation, corrosion resistance and no resistance Multiple seals, outdoor waterproof and rustproof
- 3、 Stereo light, large irradiation range, bright light effect, stylish atmosphere

SR-FGK



Model No	Watts	Size	Lamp beads	Light effect	Color temperature	Voltage	Power Factor	Waterproof level	Pcs
SR-FGK30W	30W	ø505*81*715mm	SMD3030	140LM	3000K-6500K	AC100-277V	>0.95	IP66	1
SR-FGK40W	40W	ø505*81*715mm	SMD3030	140LM	3000K-6500K	AC100-277V	>0.95	IP66	1
SR-FGK50W	50W	ø505*81*715mm	SMD3030	140LM	3000K-6500K	AC100-277V	>0.95	IP66	1
SR-FGK60W	60W	ø505*81*715mm	SMD3030	140LM	3000K-6500K	AC100-277V	>0.95	IP66	1
SR-FGK80W	80W	ø505*81*715mm	SMD3030	140LM	3000K-6500K	AC100-277V	>0.95	IP66	1
SR-FGK100W	100W	ø505*81*715mm	SMD3030	140LM	3000K-6500K	AC100-277V	>0.95	IP66	1
SR-FGK120W	120W	ø505*81*715mm	SMD3030	140LM	3000K-6500K	AC100-277V	>0.95	IP66	1
SR-FGK150W	150W	ø505*81*715mm	SMD3030	140LM	3000K-6500K	AC100-277V	>0.95	IP66	1



LED COURTYARD LAMP SERIES

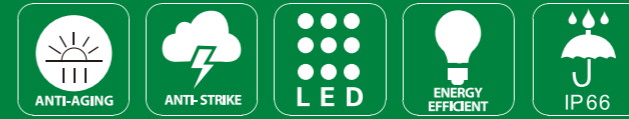

Features

- 1、 A splicing LED projection lamp, Can be spliced with different wattage, free combination
- 2、 All-aluminum die-cast shell, good heat dissipation, corrosion resistance and no resistance Multiple seals, outdoor waterproof and rustproof
- 3、 Stereo light, large irradiation range, bright light effect, stylish atmosphere

SR-FGV



Model No	Watts	Size	Lamp beads	Light effect	Color temperature	Voltage	Power Factor	Waterproof level	Pcs
SR-FGV30W	30W	450*65*525mm	SMD3030	140LM	3000K-6500K	AC100-277V	>0.95	IP66	1
SR-FGV40W	40W	450*65*525mm	SMD3030	140LM	3000K-6500K	AC100-277V	>0.95	IP66	1
SR-FGV50W	50W	450*65*525mm	SMD3030	140LM	3000K-6500K	AC100-277V	>0.95	IP66	1
SR-FGV60W	60W	450*65*525mm	SMD3030	140LM	3000K-6500K	AC100-277V	>0.95	IP66	1
SR-FGV80W	80W	450*65*525mm	SMD3030	140LM	3000K-6500K	AC100-277V	>0.95	IP66	1
SR-FGV100W	100W	450*65*525mm	SMD3030	140LM	3000K-6500K	AC100-277V	>0.95	IP66	1
SR-FGV120W	120W	450*65*525mm	SMD3030	140LM	3000K-6500K	AC100-277V	>0.95	IP66	1
SR-FGV150W	150W	450*65*525mm	SMD3030	140LM	3000K-6500K	AC100-277V	>0.95	IP66	1



LED TOWER CRANE LIGHT SERIES



Features

- 1、 A splicing LED projection lamp, Can be spliced with different wattage, free combination
- 2、 All-aluminum die-cast shell, good heat dissipation, corrosion resistance and no resistance Multiple seals, outdoor waterproof and rustproof
- 3、 Stereo light, large irradiation range, bright light effect, stylish atmosphere

SR-TCP



Model No	Watts	Size	Lamp beads	Light effect	Color temperature	Voltage	Power Factor	Waterproof level	Pcs
SR-TCP800W	800W	365*410*230mm	SMD3030	150LM	3000K-6500K	AC100-277V	>0.95	IP66	1
SR-TCP1000W	1000W	440*410*230mm	SMD3030	150LM	3000K-6500K	AC100-277V	>0.95	IP66	1
SR-TCP1500W	1500W	535*410*230mm	SMD3030	150LM	3000K-6500K	AC100-277V	>0.95	IP66	1



LED TOWER CRANE LIGHT SERIES

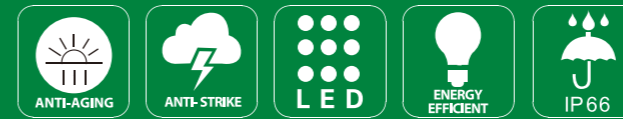

Features

- 1、 A splicing LED projection lamp, Can be spliced with different wattage, free combination
- 2、 All-aluminum die-cast shell, good heat dissipation, corrosion resistance and no resistance Multiple seals, outdoor waterproof and rustproof
- 3、 Stereo light, large irradiation range, bright light effect, stylish atmosphere

SR-TCY



Model No	Watts	Size	Lamp beads	Light effect	Color temperature	Voltage	Power Factor	Waterproof level	Pcs
SR-TCY150W	150W	250*270*135mm	SMD3030	150LM	3000K-6500K	AC100-277V	>0.95	IP66	1
SR-TCY200W	200W	270*270*135mm	SMD3030	150LM	3000K-6500K	AC100-277V	>0.95	IP66	1
SR-TCY300W	300W	270*270*135mm	SMD3030	150LM	3000K-6500K	AC100-277V	>0.95	IP66	1
SR-TCY400W	400W	310*270*135mm	SMD3030	150LM	3000K-6500K	AC100-277V	>0.95	IP66	1
SR-TCY500W	500W	310*330*170mm	SMD3030	150LM	3000K-6500K	AC100-277V	>0.95	IP66	1
SR-TCY600W	600W	365*330*170mm	SMD3030	150LM	3000K-6500K	AC100-277V	>0.95	IP66	1
SR-TCY700W	700W	365*330*170mm	SMD3030	150LM	3000K-6500K	AC100-277V	>0.95	IP66	1



LED TOWER CRANE LIGHT SERIES



Features

- 1、A splicing LED projection lamp, Can be spliced with different wattage, free combination
- 2、 All-aluminum die-cast shell, good heat dissipation, corrosion resistance and no resistance Multiple seals,outdoor waterproof and rustproof
- 3、 Stereo light, large irradiation range, bright light effect, stylish atmosphere



SR-TCE



Model No	Watts	Size	Lamp beads	Light effect	Color temperature	Voltage	Power Factor	Waterproof level	Pcs
SR-TCE100W	100W	155*285*160mm	SMD3030	150LM	3000K-6500K	AC100-277V	>0.95	IP66	1
SR-TCE120W	120W	190*285*160mm	SMD3030	150LM	3000K-6500K	AC100-277V	>0.95	IP66	1
SR-TCE150W	150W	190*285*160mm	SMD3030	150LM	3000K-6500K	AC100-277V	>0.95	IP66	1
SR-TCE200W	200W	190*285*160mm	SMD3030	150LM	3000K-6500K	AC100-277V	>0.95	IP66	1
SR-TCE300W	300W	190*285*160mm	SMD3030	150LM	3000K-6500K	AC100-277V	>0.95	IP66	1
SR-TCE400W	400W	255*285*160mm	SMD3030	150LM	3000K-6500K	AC100-277V	>0.95	IP66	1
SR-TCE500W	500W	330*285*160mm	SMD3030	150LM	3000K-6500K	AC100-277V	>0.95	IP66	1



LED TOWER CRANE LIGHT SERIES

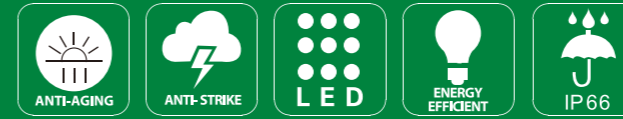

Features

- 1、A splicing LED projection lamp, Can be spliced with different wattage, free combination
- 2、 All-aluminum die-cast shell, good heat dissipation, corrosion resistance and no resistance Multiple seals,outdoor waterproof and rustproof
- 3、 Stereo light, large irradiation range, bright light effect, stylish atmosphere



SR-TCU



Model No	Watts	Size	Lamp beads	Light effect	Color temperature	Voltage	Power Factor	Waterproof level	Pcs
SR-TCU	150W-200W	250*270*135mm	SMD3030	150LM	3000K-6500K	AC100-277V	>0.95	IP66	1
SR-TCU	300W-400W	310*270*135mm	SMD3030	150LM	3000K-6500K	AC100-277V	>0.95	IP66	1
SR-TCU	500W-600W	365*330*170mm	SMD3030	150LM	3000K-6500K	AC100-277V	>0.95	IP66	1
SR-TCU	800W	365*330*170mm	SMD3030	150LM	3000K-6500K	AC100-277V	>0.95	IP66	1
SR-TCU	1000W	440*410*230mm	SMD3030	150LM	3000K-6500K	AC100-277V	>0.95	IP66	1

